



planet packaging

*We Love
Folder's*



....and you will too!

IT ALL BEGAN IN 1947.

"Don't you have a stronger envelope that will last longer?"

This is the question that inspired the first document folder and from there the vision grew! Now, 70+ years later, Admore® still offers you the largest line of premium presentation folders — **unmatched in quality and price.**



IT'S EASY BEING GREEN.

If terms like "post consumer waste" and "mobius loop" have you running for cover, just relax. Admore® has plenty of eco-friendly options and will be glad to advise you. There is never a charge to add the appropriate environmental label to your folder.



TELL YOUR STORY.

Whether you're a large corporation or a small enterprise, you build relationships with customers. You tell them something about yourself with every contact. To make that best first impression, a folder is an excellent marketing tool. Before it's even opened, an Admore® folder projects your style and professionalism.



WAVE YOUR FLAG!

Republican? Democrat? Regardless of political or government affiliation, folders don't choose sides. All Admore® products are manufactured in America. If you need a union label or a "Printed in the U.S.A." tagline on your project, just let us know. We'll be happy to add it free of charge.



FEEL GOOD ABOUT IT.

We want you to open your box of folders and smile. With that thought in mind, every Admore® product is backed by our 100% satisfaction guarantee. If we didn't do it right, we'll make it right. Period.



TABLE OF CONTENTS

QUICK-SHIP ECONOMY FOLDER (Includes Ground Shipping)

Plain	2
Printed (Four Color Process, 1 or 2 PMS) . . .	2-3
Foil Stamped	2-3
Recycled (100% post-consumer Eco Kraft).	2-3

LARGE PRESENTATION FOLDERS

Best Sellers (9" x12" round or square corners) . .	4-5
Standard Styles.	6-9
Legal Size	10-11
Reinforced Edge.	12-13
Capacity	14-15
Three Panel	16-17

TAX FOLDERS & REPORT COVERS18-19

SMALL & MID-SIZE FOLDERS 20-21

CARD SLOTS, SLITS & SPINE ATTACHMENTS . . . 22

INSERTS (STEPPED & STITCHED) 23

CERTIFICATE COVERS. 24

POCKET PAGES. 25

FILE FOLDERS 26

KEY & CARD HOLDERS. 27

PHOTO HOLDERS. 28-29

PORTFOLIOS 30-31

DISC COVERS & MAILERS 32

INDEX TABS 33

BINDERS. 34-35

DOCUMENT FOLDERS

Design Your Own	36-37
Standard Designs	38-40

DIGITAL STITCHED BOOKLETS 41

DIGITAL FOLDERS (Short Run 4CP) 42-43

COLORWORX® PRODUCTS 44-45

- Business Cards
- Postcards
- Door Hangers
- Rack Cards
- Tri-Fold Brochures

CUSTOMIZATION 46

IMPORTANT INFORMATION 47-48

COLOR CHARTS Inside Back Cover

NEW PRODUCTS

Want to see what's new?
Watch for this symbol and you'll find it!

Expect MORE. Get MORE.

 Look for this icon for helpful tips,
marketing advice and additional information.

BEST SELLERS

If you love it and keep buying it,
we've tagged it with a little red heart.



QUICK-SHIP ECONOMY FOLDER



Need a quick fix? One standard folder. Choose plain, printed or foil stamped.
Ground shipping included in the price!

Product Specifications

- The industry's most popular folder – 9" x 12" (square corners) with two 4" pockets
- Four corner card slots in the right pocket only
- Available plain, printed or foil stamped

Stock Choices

- Base stocks included in price
- Additional charge for other stock groups – 130 lb. Dull cover not available
- Recycled Folder: order 18 PT 100% PC Eco Kraft

Schedule Requirements

- Complete order information and art file must be received by NOON EST (M-F)
- Submit art on template, follow art guidelines
- Service not provided on weekends/holidays
- Proof requires additional production time

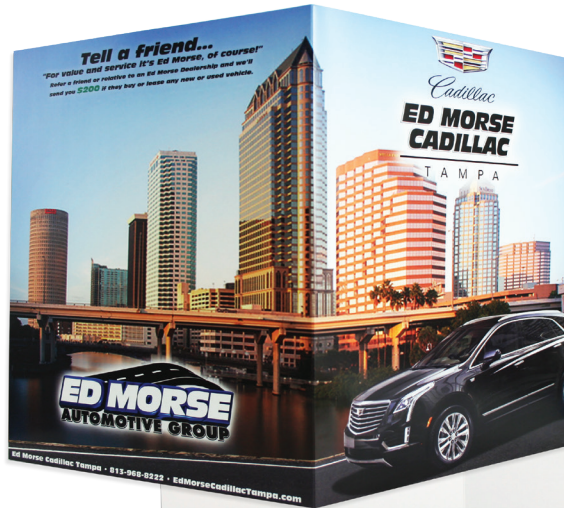

08-96-4CP



UPS Ground Shipping Included in Price!
One location within contiguous USA only

QUICK-SHIP ECONOMY FOLDER

♥ 08-96

Available options:

- Plain, no imprint
- Four color process
- One PMS color, 35% ink coverage
- Two PMS colors, 35% ink coverage
- Foil Stamped, one area up to 15 sq. inches
- Recycled Folder: add Eco Kraft stock upcharge

Price: shown below

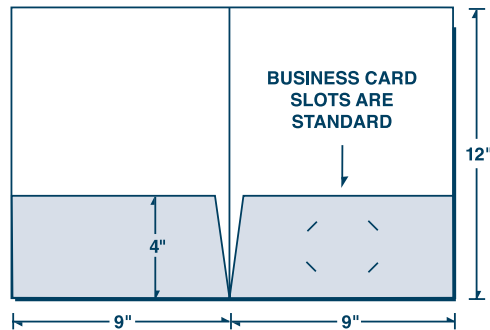

UPS Ground Shipping included to ONE location within the contiguous USA Only

QUICK-SHIP ECONOMY FOLDERS – BASE STOCK PRICE	50	100	250	500	1000	1500	2000	2500	3000	4000	5000	
08-96-PLAIN	24 Hours	5.133	2.987	1.722	1.108	0.835	0.732	0.702	0.685	0.615	0.572	0.550
08-96-4CP Four Color Process	24 Hours	10.080	5.865	2.755	1.728	1.198	1.025	0.923	0.853	0.807	0.718	0.663
08-96-1PMS No Heavy Coverage	5 Production Days	N/A	3.978	2.073	1.242	0.915	0.768	0.737	0.707	0.683	0.627	0.595
08-96-2PMS No Heavy Coverage	5 Production Days	N/A	5.578	2.715	1.592	1.127	0.913	0.864	0.820	0.783	0.709	0.660
08-96-FOIL One Area up to 15 sq. in.	3 Production Days	6.423	3.588	2.032	1.270	1.000	0.847	0.788	0.768	0.697	0.637	0.610
OPTIONS: ADD TO BASE												
Group A Stocks		0.308	0.275	0.192	0.137	0.120	0.113	0.110	0.108	0.105	0.103	0.102
Group B Stocks		0.485	0.433	0.307	0.227	0.200	0.187	0.182	0.177	0.172	0.168	0.167
Group C Stocks		0.740	0.688	0.472	0.338	0.298	0.278	0.272	0.263	0.255	0.252	0.248
Group D Stocks		1.075	0.988	0.687	0.493	0.435	0.410	0.400	0.388	0.378	0.375	0.372
Group E Stocks		1.182	1.087	0.833	0.772	0.733	0.727	0.720	0.713	0.707	0.700	0.693
Group F Stocks		1.300	1.250	1.042	1.032	1.002	0.982	0.972	0.962	0.952	0.942	0.932
Group G Stocks		1.495	1.468	1.282	1.268	1.232	1.232	1.232	1.232	1.232	1.232	1.232
18 PT Eco Kraft 100% Recycled Stock		0.308	0.275	0.192	0.137	0.120	0.113	0.110	0.108	0.105	0.103	0.102
Aqueous Coating - Flood Gloss (on print orders)		FREE	FREE	FREE	FREE	FREE	FREE	FREE	FREE	FREE	FREE	FREE

(R) Price shown is per piece

QUICK-SHIP ECONOMY FOLDER



08-96-4CP

FOUR COLOR PROCESS PRINTED

♥ 08-96-4CP

- Front & back cover, plus pockets
- Orders are run to standard color densities
- FREE overall GLOSS aqueous coating only
- White or ivory stocks recommended
- See schedule requirements page 2
- **24 hr. production (without proof)**

Price: see page 2



08-96-4CP



08-96-2PMS

PMS PRINTED

♥ 08-96-1PMS or 08-96-2PMS

- One or two PMS ink color(s)
- Provides spot color accuracy
- Front & back cover, plus pockets
- No heavy coverage – max. 35% ink coverage
- FREE overall GLOSS aqueous coating only
- See schedule requirements page 2
- **5 production days (without proof)**

Price: see page 2



08-96-1PMS on Yellow Vellum



08-96-FOIL Dark Blue Linen with Metallic Silver foil

< 08-96-FOIL Red Hopsack with Metallic Silver foil

< 08-96-FOIL Mahogany Linen with Metallic Lime foil

FOIL STAMPED

♥ 08-96-FOIL

- One standard foil color
- Front cover, one area up to 15 sq. inches
- See schedule requirements page 2
- **3 production days (without proof)**

Price: see page 2

08-96-FOIL > Deep Black Linen with Metallic Gold foil



♻️ 100% PCW RECYCLED ECO FOLDER

Both our PMS PRINTED and FOIL STAMPED Quick-Ship Economy folders can be ordered on our 18 PT Eco Kraft 100% recycled stock – simply add in the Eco Kraft stock upcharge!

Price: base price **plus** the 18 PT Eco Kraft upcharge on page 2



08-96-2PMS on Eco Kraft 100% ♻️



08-96-FOIL Eco Kraft 100% ♻️ with Metallic Gold foil

OUR BEST SELLING FOLDERS



We sell a lot of these folders! 9" x 12" round or square corners; one or two pockets – at a LOWER price – MORE value for you!

Product Specifications

- Available printed, foil stamped or embossed
- Base stocks included in price – additional charge for other stock groups
- FREE overall GLOSS, SATIN or MATTE aqueous coating on print orders
- A variety of card slots, brochure slits & other pocket options are available FREE – see page 22 or refer to design templates

Production Schedule

- Four color process (4/0) or foil stamp: 5 production days
- 1 - 4 PMS colors or embossing: 7 production days

Other Options

- 7 - 10 production days
- Soft-Touch aqueous coating: add 1 production day
- Spine Attachments: add 3 - 5 production days



08-01 printed 2PMS (2/1)



< 08-28 foil stamp + emboss Coral Vellum with Metallic Silver foil

✓ You save when you shop these items! These products offer our best value and many options.

08-28 printed 2PMS >

BEST SELLING FOLDERS – BASE STOCK PRICE	250	500	1000	1500	2000	2500	3000	5000	7500	10000
Print One PMS Color - No Heavy Coverage	2.367	1.383	0.944	0.778	0.722	0.688	0.663	0.548	0.501	0.463
Print Two PMS Colors - No Heavy Coverage	3.008	1.733	1.156	0.923	0.849	0.801	0.763	0.613	0.559	0.517
Four Color Process	2.700	1.678	1.143	0.986	0.885	0.813	0.764	0.617	0.555	0.496
Foil Stamp or Emboss - One Area up to 36 sq. in.	1.960	1.337	0.938	0.786	0.767	0.735	0.709	0.592	0.557	0.527
Foil Stamp + Emboss (same copy) - One Area up to 36 sq. in.	3.100	1.967	1.313	1.084	1.020	0.975	0.944	0.793	0.750	0.709
OPTIONS: ADD TO BASE										
Additional PMS Color/Heavy Ink Coverage (per side)	0.642	0.350	0.212	0.145	0.127	0.113	0.100	0.065	0.059	0.054
Four Color Process (2nd side)	1.706	0.871	0.513	0.387	0.319	0.274	0.251	0.195	0.169	0.166
2nd Foil Area - Same Color, Same Side - up to 36 sq. in. (on foil orders)	0.367	0.190	0.105	0.075	0.060	0.050	0.043	0.032	0.023	0.020
Group A Stocks	0.192	0.137	0.120	0.113	0.110	0.108	0.105	0.102	0.098	0.098
Group B Stocks	0.307	0.227	0.200	0.187	0.182	0.177	0.172	0.167	0.162	0.162
Group C Stocks	0.472	0.338	0.298	0.278	0.272	0.263	0.255	0.248	0.240	0.235
Group D Stocks	0.687	0.493	0.435	0.410	0.400	0.388	0.378	0.372	0.365	0.362
Group E Stocks	0.833	0.772	0.733	0.727	0.720	0.713	0.707	0.693	0.687	0.680
Group F Stocks	1.042	1.032	1.002	0.982	0.972	0.962	0.952	0.932	0.922	0.912
Group G Stocks	1.282	1.268	1.232	1.232	1.232	1.232	1.232	1.232	1.232	1.232
Aqueous Coating - Flood Gloss, Satin or Matte (on print orders)	FREE	FREE	FREE	FREE	FREE	FREE	FREE	FREE	FREE	FREE
Aqueous Coating - Flood Soft-Touch (on print orders)	1.171	0.654	0.379	0.275	0.223	0.204	0.186	0.127	0.117	0.106
UV Coating - Flood High Gloss	0.497	0.302	0.186	0.161	0.152	0.133	0.124	0.116	0.114	0.102
Lamination - Gloss	0.629	0.407	0.335	0.296	0.279	0.276	0.274	0.267	0.262	0.262
Lamination - Matte	0.789	0.624	0.493	0.456	0.436	0.425	0.420	0.408	0.401	0.395
Lamination - Soft-Touch	0.954	0.717	0.585	0.539	0.518	0.504	0.495	0.477	0.468	0.465
Spine Attachments (white card stock or matching - see page 22)	0.891	0.876	0.869	0.851	0.847	0.845	0.842	0.836	0.831	0.814

(R) Price shown is per piece

OUR BEST SELLING FOLDERS

08-01 printed 4CP



^ 08-01
blind embossed on
Red Hopsack

ROUND CORNERS TWO POCKETS ♥ 08-01

Price: see page 4



< 08-01 printed 2PMS
on ECO Kraft 100% ♻️

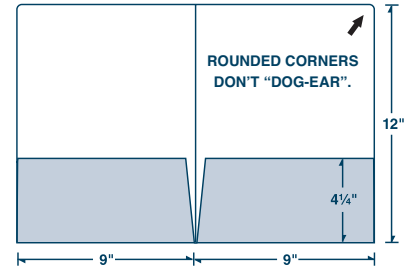

08-04 printed 4CP (4/4) for optional
stepped inserts see page 23



< 08-04 foil stamped
Deep Black Linen with
Metallic Silver foil

ROUND CORNERS ONE POCKET ♥ 08-04

Right pocket only

Price: see page 4

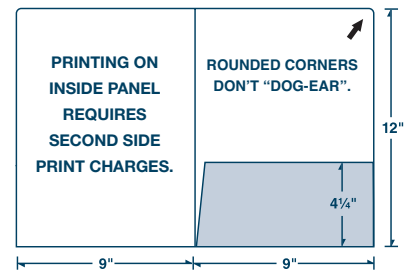

< 08-28 printed 4CP (4/4)

08-28 foil stamp + emboss >
Dark Blue Linen with Metallic Gold foil



< 08-28 printed 1PMS

SQUARE CORNERS TWO POCKETS ♥ 08-28

Price: see page 4

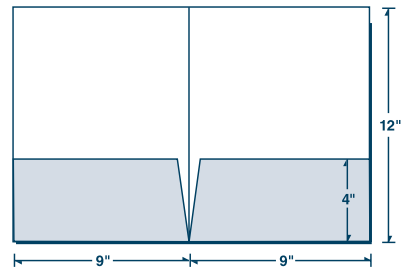

08-29 printed 2PMS (2/2)



< 08-29 printed 4CP (4/4)
for optional stepped inserts see page 23

SQUARE CORNERS ONE POCKET ♥ 08-29

Right pocket only

Price: see page 4

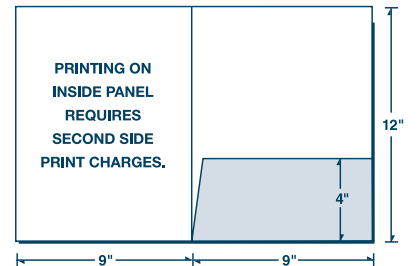

STANDARD LARGE FOLDER STYLES

MORE than a folder! Present your materials, reinforce name recognition & build brand identity.

Product Specifications

- Available printed, foil stamped or embossed
- Base stocks included in price – additional charge for other stock groups
- FREE overall GLOSS, SATIN or MATTE aqueous coating on print orders
- A variety of card slots, brochure slits & other pocket options are available FREE – see page 22 or refer to design templates

Production Schedule

- 7 - 10 production days
- Soft-Touch aqueous coating: add 1 production day
- Spine Attachments: add 3 - 5 production days

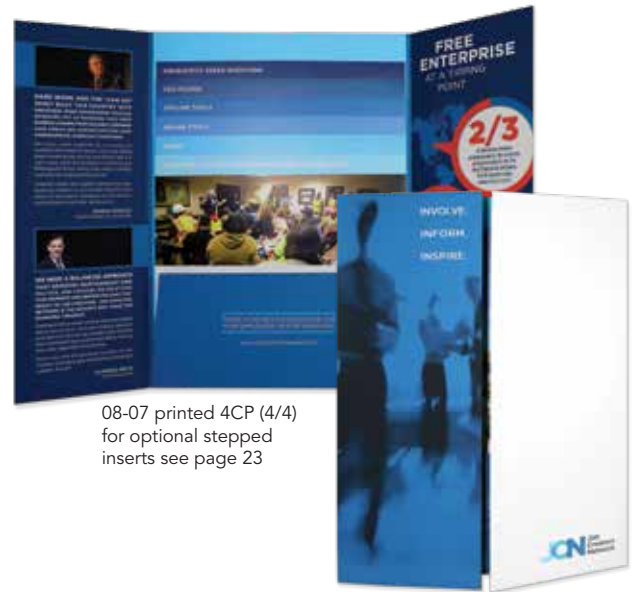

08-07 printed 4CP (4/4) for optional stepped inserts see page 23



08-63 printed 4CP

TWO CURVED POCKETS ♥ 08-63

Price: shown below

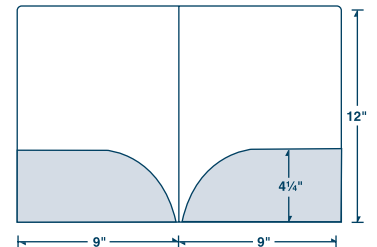

STANDARD LARGE PRESENTATION FOLDERS – BASE STOCK PRICE	250	500	1000	1500	2000	2500	3000	5000	7500	10000
Print One PMS Color - No Heavy Coverage	2.434	1.421	0.971	0.801	0.744	0.709	0.683	0.566	0.516	0.477
Print Two PMS Colors - No Heavy Coverage	3.076	1.771	1.182	0.946	0.871	0.822	0.783	0.631	0.575	0.531
Four Color Process	2.865	1.806	1.239	1.044	0.924	0.844	0.788	0.637	0.572	0.511
Foil Stamp or Emboss - One Area up to 36 sq. in.	2.027	1.374	0.964	0.809	0.788	0.756	0.729	0.609	0.572	0.542
Foil Stamp + Emboss (same copy) - One Area up to 36 sq. in.	3.167	2.004	1.339	1.107	1.041	0.996	0.964	0.811	0.766	0.723
OPTIONS: ADD TO BASE										
Additional PMS Color/Heavy Ink Coverage (per side)	0.642	0.350	0.212	0.145	0.127	0.113	0.100	0.065	0.059	0.054
Four Color Process (2nd side)	1.706	0.871	0.513	0.387	0.319	0.274	0.251	0.195	0.169	0.166
2nd Foil Area - Same Color, Same Side - up to 36 sq. in. (on foil orders)	0.367	0.190	0.105	0.075	0.060	0.050	0.043	0.032	0.023	0.020
Group A Stocks	0.192	0.137	0.120	0.113	0.110	0.108	0.105	0.102	0.098	0.098
Group B Stocks	0.307	0.227	0.200	0.187	0.182	0.177	0.172	0.167	0.162	0.162
Group C Stocks	0.472	0.338	0.298	0.278	0.272	0.263	0.255	0.248	0.240	0.235
Group D Stocks	0.687	0.493	0.435	0.410	0.400	0.388	0.378	0.372	0.365	0.362
Group E Stocks	0.833	0.772	0.733	0.727	0.720	0.713	0.707	0.693	0.687	0.680
Group F Stocks	1.042	1.032	1.002	0.982	0.972	0.962	0.952	0.932	0.922	0.912
Group G Stocks	1.282	1.268	1.232	1.232	1.232	1.232	1.232	1.232	1.232	1.232
Upcharge: 08-06, 08-08, 08-30, 08-32, 08-33, 08-55, 08-61, 08-80, 08-81, 08-82	0.408	0.360	0.299	0.297	0.290	0.277	0.263	0.260	0.253	0.240
Upcharge: 08-57, 08-58, 08-59	1.470	0.859	0.551	0.523	0.505	0.472	0.466	0.444	0.412	0.383
Aqueous Coating - Flood Gloss, Satin or Matte (on print orders)	FREE	FREE	FREE	FREE	FREE	FREE	FREE	FREE	FREE	FREE
Aqueous Coating - Flood Soft-Touch (on print orders)	1.171	0.654	0.379	0.275	0.223	0.204	0.186	0.127	0.117	0.106
UV Coating - Flood High Gloss	0.497	0.302	0.186	0.161	0.152	0.133	0.124	0.116	0.114	0.102
Lamination - Gloss	0.629	0.407	0.335	0.296	0.279	0.276	0.274	0.267	0.262	0.262
Lamination - Matte	0.789	0.624	0.493	0.456	0.436	0.425	0.420	0.408	0.401	0.395
Lamination - Soft-Touch	0.954	0.717	0.585	0.539	0.518	0.504	0.495	0.477	0.468	0.465
Spine Attachments (white card stock or matching - see page 22)	0.891	0.876	0.869	0.851	0.847	0.845	0.842	0.836	0.831	0.814

(R) Price shown is per piece

STANDARD LARGE FOLDER STYLES



08-65-CON printed 4CP

STANDARD CONFORMER®

♥ 08-65-CON

Holds up to 3/8" per pocket

Price: see page 14

✓ Better than a box pocket!

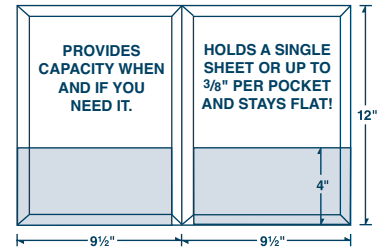

Conformer® is a registered trademark of Conformer® Products. A patent number will be added to Conformer® Products.



08-02 printed 4CP

BACKBONE 08-02

1/2" double score backbone (shown)

08-03

1/2" triple score backbone

♥ 08-11

1/4" double score backbone (shown)

Price: see page 6

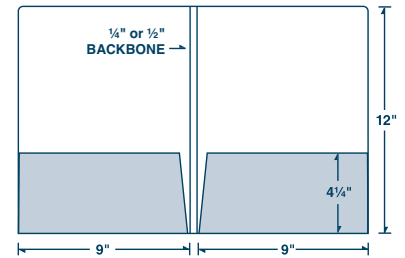

08-22 printed 4CP (4/4)

FILE TAB

♥ 08-22

Two pockets (shown)

08-21

One right pocket only

Price: see page 6

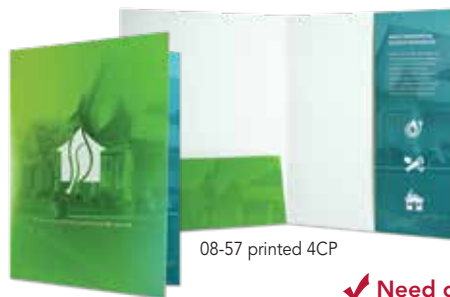
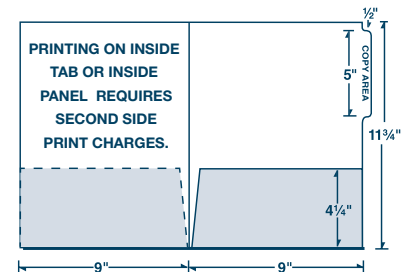

08-57 printed 4CP

REGULAR & VERTICAL POCKETS

♥ 08-57

Vertical pocket on the right (shown)

08-59

Vertical pocket on the left

Price: base price **plus** upcharge on page 6 - call for pricing if laminating

✓ Need capacity pockets? See Item 08-47-CON on page 8.

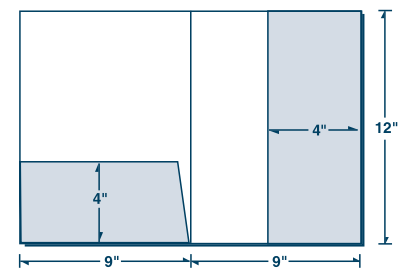

08-58 printed 4CP

TWO VERTICAL POCKETS

08-58

Price: base price **plus** upcharge on page 6 - call for pricing if laminating

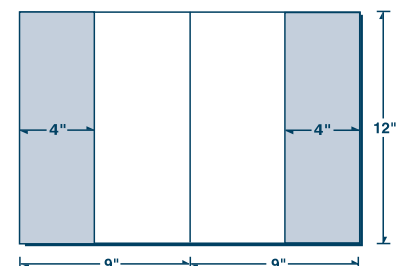

STANDARD LARGE FOLDER STYLES



08-47-CON printed 4CP (4/4)

CONFORMER® REGULAR & VERTICAL POCKETS

NEW 08-47-CON

Holds up to 3/8" per pocket

Price: base price **plus** upcharge on page 14 - call for pricing if laminating

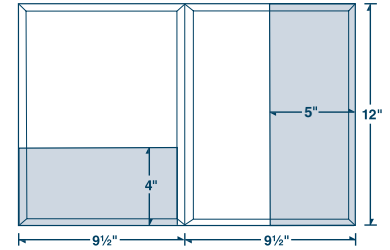

NEW

Conformer® is a registered trademark of Conformer® Products. A patent number will be added to Conformer® Products.



08-80 printed 2PMS

WAVY POCKETS

08-80

5" pocket on right (shown)

08-81

5" pocket on left

Price: base price **plus** upcharge on page 6 - call for pricing if laminating

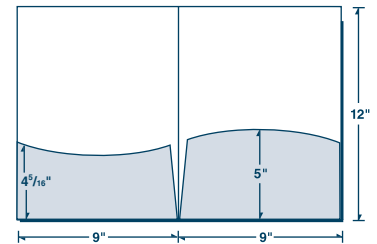

08-61 printed 4CP (4/4)

DIAGONAL POCKETS

08-61

Two diagonal pockets

Price: base price **plus** upcharge on page 6 - call for pricing if laminating

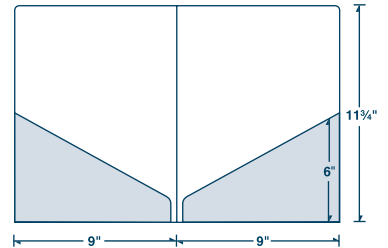

08-82 printed 4CP

TALL POCKETS

08-82

Two 6" tall pockets

Price: base price **plus** upcharge on page 6 - call for pricing if laminating

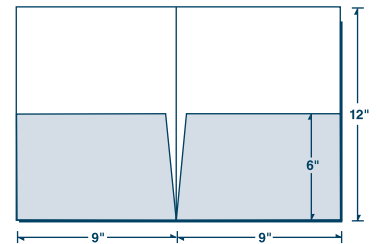

✓ **Taller pockets hold your inserts securely and provide more copy area!**



08-30 printed 2PMS (2/1)

SERPENTINE CUT ONE POCKET

♥ 08-30

Serpentine shaped pocket and front cover

Price: base price upcharge on page 6 - call for pricing if laminating

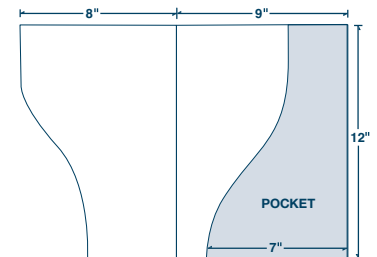

STANDARD LARGE FOLDER STYLES

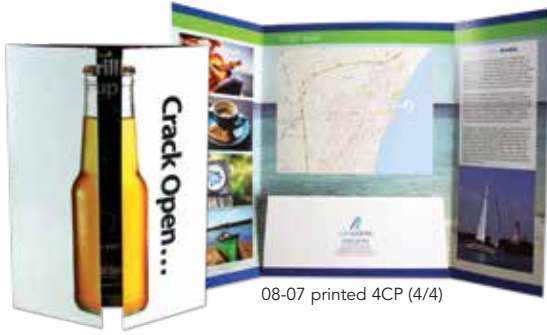

08-07 printed 4CP (4/4)

ONE POCKET GATEFOLD 08-07

Gatefold front cover with single center pocket

Price: see page 6 – lamination not recommended on this item

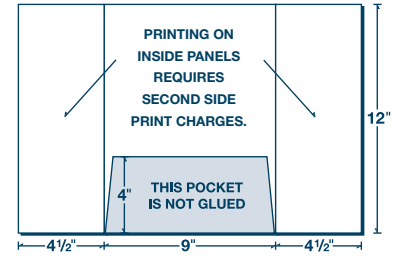

✓ Add impact! Feature a cross-over element in your front cover artwork.



08-32 printed 4CP

SMALL & VERTICAL POCKETS ♥ 08-32

Combination pocket style, small & vertical

Price: base price **plus** upcharge on page 6

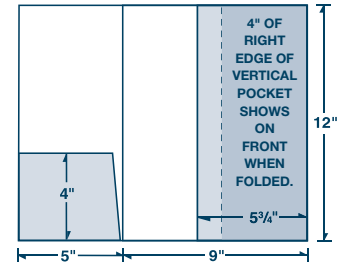

✓ Smaller pocket is great for material swatches, brochures and more.



08-52 printed 4CP (4/4)

ONE POCKET TUCK TAB 08-52

One large pocket with a closure notch

Corner style card slots are not available

Price: see page 6

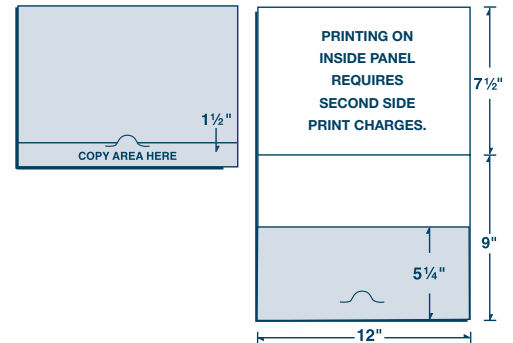

08-06 printed 4CP (4/4)

LANDSCAPE POCKET 08-06

One right pocket only (shown)

NEW 08-33
Two landscape pockets

Price: base price **plus** upcharge on page 6 - call for pricing if laminating

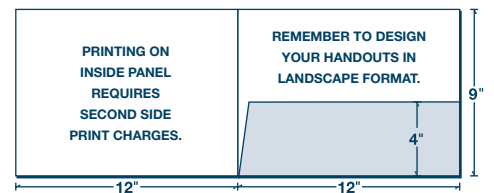

✓ Landscape folders are great for panoramic images!



08-08 printed 4CP (4/1)

WRAP-AROUND FLAP 08-55

Tuck tab on flap (shown)

08-08
3 3/4" info flap without tuck tab;
9" front cover without slot (photo at left)

Price: base price **plus** upcharge on page 6 - call for pricing if laminating

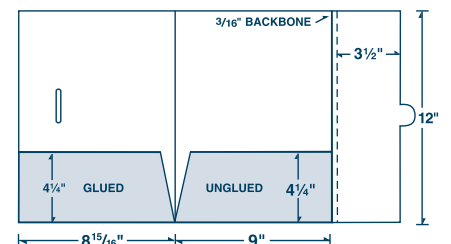

LEGAL SIZE FOLDERS

Need a safe place for oversized documents? Our folders are perfect for real estate, mortgage, banking, legal, credit union, title & MORE!

Product Specifications

- Available printed, foil stamped or embossed
- Base stocks included in price – additional charge for other stock groups
- FREE overall GLOSS, SATIN or MATTE aqueous coating on print orders
- A variety of card slots, brochure slits & other pocket options are available FREE – see page 22 or refer to design templates

Production Schedule

- 7 - 10 production days
- Soft-Touch aqueous coating: add 1 production day

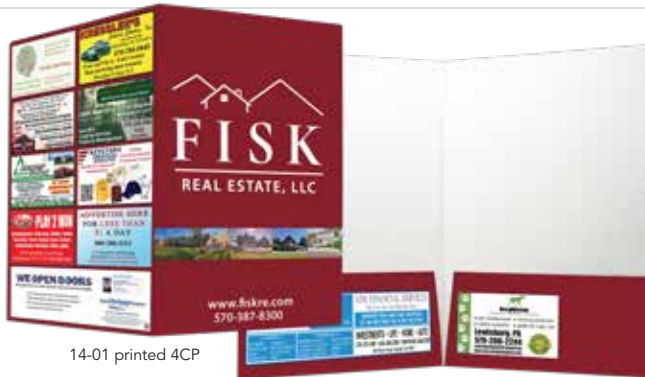

14-01 printed 4CP

LEGAL 4½" POCKETS

♥ 14-01

with round corners (shown)

14-28

with square corners

Price: shown below

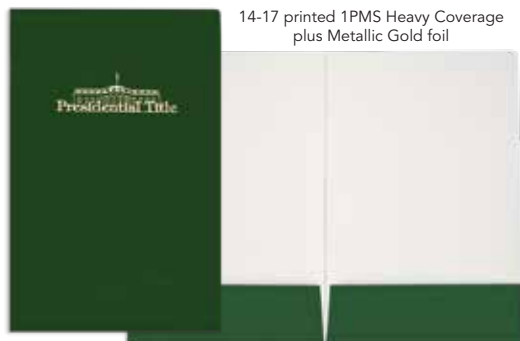
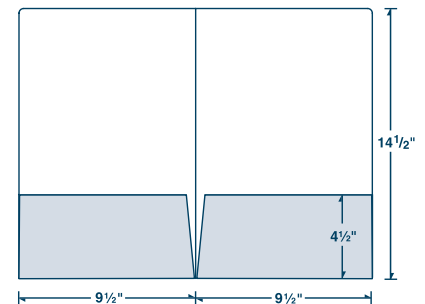

14-17 printed 1PMS Heavy Coverage plus Metallic Gold foil

LEGAL 3" POCKETS

14-17

3" pockets show off more of your inserts

Price: shown below

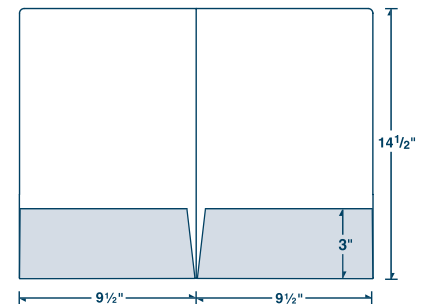

LEGAL SIZE FOLDERS – BASE STOCK PRICE	250	500	1000	1500	2000	2500	3000	5000	7500	10000
Print One PMS Color - No Heavy Coverage	3.367	1.983	1.354	1.127	1.038	0.993	0.961	0.775	0.708	0.655
Print Two PMS Colors - No Heavy Coverage	4.009	2.333	1.566	1.271	1.165	1.106	1.061	0.840	0.767	0.709
Four Color Process	3.798	2.368	1.623	1.369	1.218	1.128	1.066	0.847	0.763	0.689
Foil Stamp or Emboss - One Area up to 36 sq. in.	2.961	1.936	1.348	1.134	1.082	1.040	1.007	0.819	0.764	0.719
Foil Stamp + Emboss (same copy) - One Area up to 36 sq. in.	4.101	2.566	1.723	1.433	1.335	1.280	1.242	1.020	0.958	0.901
OPTIONS: ADD TO BASE										
Additional PMS Color/Heavy Ink Coverage (per side)	0.642	0.350	0.212	0.145	0.127	0.113	0.100	0.065	0.059	0.054
Four Color Process (2nd side)	1.706	0.871	0.513	0.387	0.319	0.274	0.251	0.195	0.169	0.166
2nd Foil Area - Same Color, Same Side - up to 36 sq. in. (on foil orders)	0.367	0.190	0.105	0.075	0.060	0.050	0.043	0.032	0.023	0.020
Group A Stocks	0.192	0.137	0.120	0.113	0.110	0.108	0.105	0.102	0.098	0.098
Group B Stocks	0.307	0.227	0.200	0.187	0.182	0.177	0.172	0.167	0.162	0.162
Group C Stocks	0.472	0.338	0.298	0.278	0.272	0.263	0.255	0.248	0.240	0.235
Group D Stocks	0.687	0.493	0.435	0.410	0.400	0.388	0.378	0.372	0.365	0.362
Group E Stocks	0.833	0.772	0.733	0.727	0.720	0.713	0.707	0.693	0.687	0.680
Group F Stocks	1.042	1.032	1.002	0.982	0.972	0.962	0.952	0.932	0.922	0.912
Group G Stocks	1.282	1.268	1.232	1.232	1.232	1.232	1.232	1.232	1.232	1.232
Upcharge: 14-13, 14-65-CON, 28-13, 29-13	0.339	0.205	0.184	0.182	0.173	0.154	0.136	0.101	0.078	0.069
Aqueous Coating - Flood Gloss, Satin or Matte (on print orders)	FREE	FREE	FREE	FREE	FREE	FREE	FREE	FREE	FREE	FREE
Aqueous Coating - Flood Soft-Touch (on print orders)	1.171	0.654	0.379	0.275	0.223	0.204	0.186	0.127	0.117	0.106
UV Coating - Flood High Gloss	0.497	0.302	0.186	0.161	0.152	0.133	0.124	0.116	0.114	0.102
Lamination - Gloss (Oversize)	0.663	0.440	0.370	0.333	0.319	0.314	0.312	0.308	0.303	0.303
Lamination - Matte (Oversize)	0.858	0.699	0.571	0.535	0.516	0.507	0.501	0.490	0.485	0.479
Lamination - Soft-Touch (Oversize)	1.055	0.801	0.693	0.650	0.628	0.613	0.604	0.586	0.579	0.573

(R) Price shown is per piece

LEGAL SIZE FOLDERS

NEW



14-13 printed 4CP

LEGAL BOX POCKETS

NEW 14-13

4 1/4" pockets with 1/4" capacity each

Price: base price **plus** upcharge on page 10

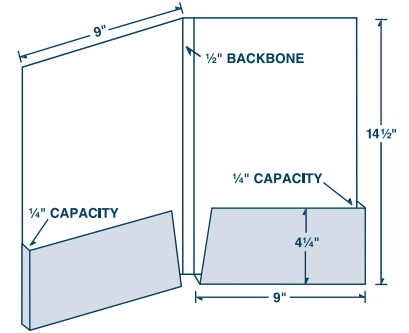

14-65-CON printed 4CP

LEGAL CONFORMER®

14-65-CON

Holds up to 3/8" per pocket

Price: base price **plus** upcharge on page 10

Conformer® is a registered trademark of Conformer® Products. A patent number will be added to Conformer® Products.

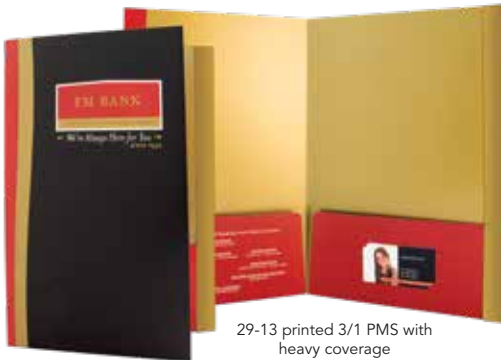
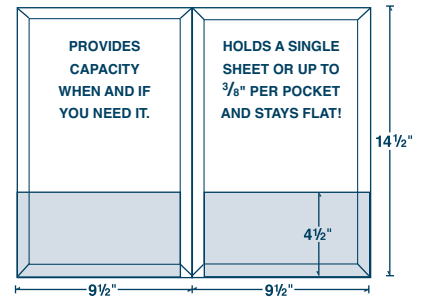

29-13 printed 3/1 PMS with heavy coverage

LEGAL REINFORCED EDGES

29-13

Side edges reinforced

Price: base price **plus** upcharge on page 10

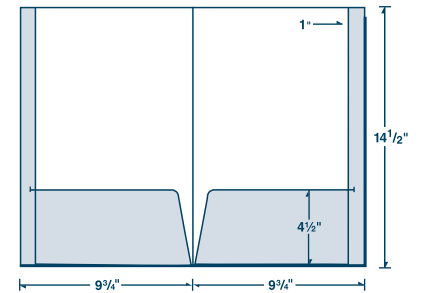

28-13 Dark Blue Linen with Metallic Silver & White foil

LEGAL EXPANDABLE POCKETS

28-13

Two 1/4" capacity expandable pockets side edges reinforced

Price: base price **plus** upcharge on page 10

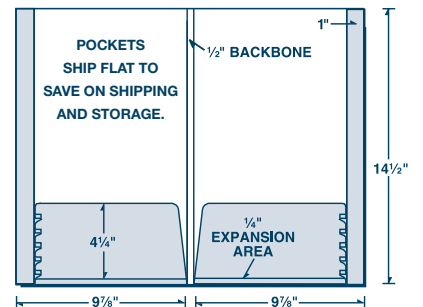

✓ Consider a legal sized portfolio instead of a folder. Regular and expansion portfolios can be found on pages 30 & 31.

REINFORCED EDGE FOLDERS

Bring in the reinforcements! Provides MORE durability when opening & closing the folder.

Product Specifications

- Available printed, foil stamped or embossed
- Base stocks included in price – additional charge for other stock groups
- FREE overall GLOSS, SATIN or MATTE aqueous coating on print orders
- Add lamination if extra durability is required – see table below
- A variety of card slots, brochure slits & other pocket options are available FREE – see page 22 or refer to design templates

Production Schedule

- 7 - 10 production days
- Soft-Touch aqueous coating: add 1 production day
- Spine Attachments: add 3 - 5 production days

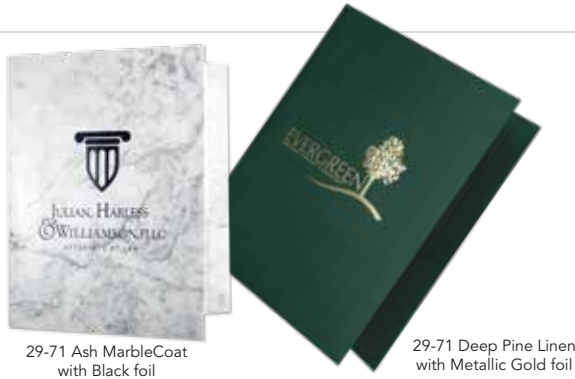

STANDARD REINFORCED EDGES

♥ 29-71

Two pockets (shown)

29-74

One right pocket only

Price: shown below

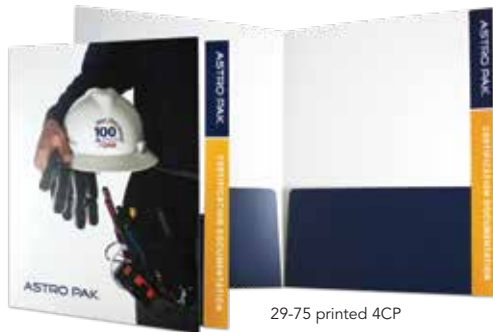
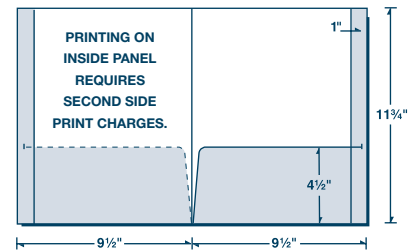

REINFORCED EDGES FILE TAB

♥ 29-75

Two pockets (shown)

29-77

One right pocket only

Price: shown below

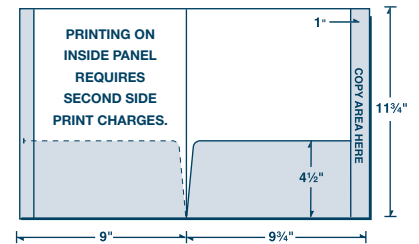

REINFORCED EDGE FOLDERS – BASE STOCK PRICE	250	500	1000	1500	2000	2500	3000	5000	7500	10000
Print One PMS Color - No Heavy Coverage	3.195	1.797	1.164	0.968	0.871	0.820	0.792	0.645	0.589	0.544
Print Two PMS Colors - No Heavy Coverage	3.836	2.147	1.376	1.113	0.998	0.933	0.892	0.710	0.648	0.598
Four Color Process	3.626	2.182	1.433	1.211	1.051	0.955	0.897	0.716	0.644	0.578
Foil Stamp or Emboss - One Area up to 36 sq. in.	2.788	1.750	1.158	0.976	0.915	0.867	0.838	0.688	0.645	0.609
Foil Stamp + Emboss (same copy) - One Area up to 36 sq. in.	3.928	2.380	1.533	1.274	1.169	1.107	1.073	0.890	0.838	0.790
OPTIONS: ADD TO BASE										
Additional PMS Color/Heavy Ink Coverage (per side)	0.642	0.350	0.212	0.145	0.127	0.113	0.100	0.065	0.059	0.054
Four Color Process (2nd side)	1.706	0.871	0.513	0.387	0.319	0.274	0.251	0.195	0.169	0.166
2nd Foil Area - Same Color, Same Side - up to 36 sq. in. (on foil orders)	0.367	0.190	0.105	0.075	0.060	0.050	0.043	0.032	0.023	0.020
Group A Stocks	0.192	0.137	0.120	0.113	0.110	0.108	0.105	0.102	0.098	0.098
Group B Stocks	0.307	0.227	0.200	0.187	0.182	0.177	0.172	0.167	0.162	0.162
Group C Stocks	0.472	0.338	0.298	0.278	0.272	0.263	0.255	0.248	0.240	0.235
Group D Stocks	0.687	0.493	0.435	0.410	0.400	0.388	0.378	0.372	0.365	0.362
Group E Stocks	0.833	0.772	0.733	0.727	0.720	0.713	0.707	0.693	0.687	0.680
Group F Stocks	1.042	1.032	1.002	0.982	0.972	0.962	0.952	0.932	0.922	0.912
Upcharge: 29-71-TOP	0.375	0.285	0.235	0.221	0.212	0.208	0.205	0.198	0.196	0.194
Aqueous Coating - Flood Gloss, Satin or Matte (on print orders)	FREE	FREE	FREE	FREE	FREE	FREE	FREE	FREE	FREE	FREE
Aqueous Coating - Flood Soft-Touch (on print orders)	1.171	0.654	0.379	0.275	0.223	0.204	0.186	0.127	0.117	0.106
UV Coating - Flood High Gloss	0.497	0.302	0.186	0.161	0.152	0.133	0.124	0.116	0.114	0.102
Lamination - Gloss	0.629	0.407	0.335	0.296	0.279	0.276	0.274	0.267	0.262	0.262
Lamination - Matte	0.789	0.624	0.493	0.456	0.436	0.425	0.420	0.408	0.401	0.395
Lamination - Soft-Touch	0.954	0.717	0.585	0.539	0.518	0.504	0.495	0.477	0.468	0.465
Spine Attachments (white card stock or matching - see page 22)	0.891	0.876	0.869	0.851	0.847	0.845	0.842	0.836	0.831	0.814

(R) Price shown is per piece

Stock and Foil selections on inside back cover. Please call for pricing on other options not listed.

REINFORCED EDGE FOLDERS



CONFORMER® RE EDGES ♥ 29-65-CON

Holds up to 3/8" per pocket

Price: see page 12

Conformer® is a registered trademark of Conformer® Products. A patent number will be added to Conformer® Products.

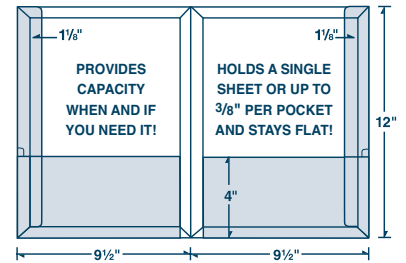

UNGLUED RE EDGES NEW 29-25

Allows for better expansion while protecting paper edges

Price: see page 12

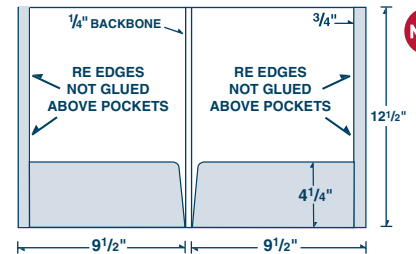

TOP & SIDE RE EDGES ♥ 29-71-TOP

Top and side reinforcement

Price: base price **plus** upcharge on page 12

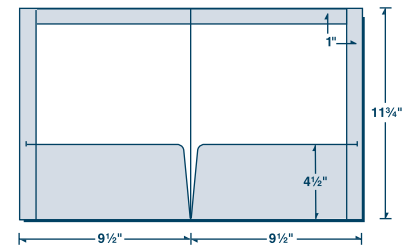

RE EDGES 1/2" BACKBONE 29-72

1/2" double score backbone

Price: see page 12

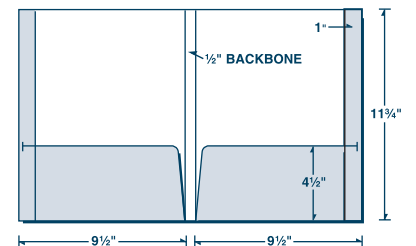

RE EDGES CONTINUOUS POCKET 29-88

Popular with schools – papers stay more secure in pockets

29-78
Same as 29-88 with standard 3-hole punch for binder (photo at left)

Price: see page 12

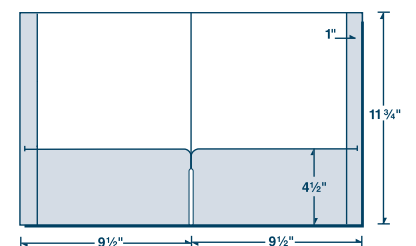

CAPACITY FOLDERS

Folders that hold MORE! Capacity in a variety of styles: box & zippered pockets and Conformer® products!

Product Specifications

- Available printed, foil stamped or embossed
- Base stocks included in price – additional charge for other stock groups
- FREE overall GLOSS, SATIN or MATTE aqueous coating on print orders
- Add lamination if extra durability is required – see table below
- A variety of card slots, brochure slits & other pocket options are available FREE – see page 22 or refer to design templates

Production Schedule

- 7 - 10 production days
- Soft-Touch aqueous coating: add 1 production day

✓ 14 PT Semi-gloss stock is a capacity folder favorite!



08-65-CON printed 4CP



08-65-CON printed 2PMS

08-65-CON
Foil stamp + Emboss
Dark Blue Linen with
Metallic Gold foil

STANDARD CONFORMER® ♥ 08-65-CON

The best capacity folder ever – patented scoring system holds up to 3/8" per pocket

Window is optional - request when ordering

Price: shown below

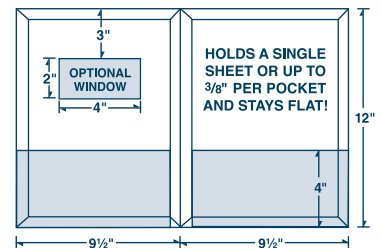

Conformer® is a registered trademark of Conformer® Products.
A patent number will be added to Conformer® Products.

CAPACITY FOLDERS – BASE STOCK PRICE	250	500	1000	1500	2000	2500	3000	5000	7500	10000
Print One PMS Color - No Heavy Coverage	3.195	1.797	1.164	0.968	0.871	0.820	0.792	0.645	0.589	0.544
Print Two PMS Colors - No Heavy Coverage	3.836	2.147	1.376	1.113	0.998	0.933	0.892	0.710	0.648	0.598
Four Color Process	3.626	2.182	1.433	1.211	1.051	0.955	0.897	0.716	0.644	0.578
Foil Stamp or Emboss - One Area up to 36 sq. in.	2.788	1.750	1.158	0.976	0.915	0.867	0.838	0.688	0.645	0.609
Foil Stamp + Emboss (same copy) - One Area up to 36 sq. in.	3.928	2.380	1.533	1.274	1.169	1.107	1.073	0.890	0.838	0.790
OPTIONS: ADD TO BASE										
Additional PMS Color/Heavy Ink Coverage (per side)	0.642	0.350	0.212	0.145	0.127	0.113	0.100	0.065	0.059	0.054
Four Color Process (2nd side)	1.706	0.871	0.513	0.387	0.319	0.274	0.251	0.195	0.169	0.166
2nd Foil Area - Same Color, Same Side - up to 36 sq. in. (on foil orders)	0.367	0.190	0.105	0.075	0.060	0.050	0.043	0.032	0.023	0.020
Group A Stocks	0.192	0.137	0.120	0.113	0.110	0.108	0.105	0.102	0.098	0.098
Group B Stocks	0.307	0.227	0.200	0.187	0.182	0.177	0.172	0.167	0.162	0.162
Group C Stocks	0.472	0.338	0.298	0.278	0.272	0.263	0.255	0.248	0.240	0.235
Group D Stocks	0.687	0.493	0.435	0.410	0.400	0.388	0.378	0.372	0.365	0.362
Group E Stocks	0.833	0.772	0.733	0.727	0.720	0.713	0.707	0.693	0.687	0.680
Group F Stocks	1.042	1.032	1.002	0.982	0.972	0.962	0.952	0.932	0.922	0.912
Upcharge: 08-13, 08-17, 08-20, 08-53, 29-82-CON	0.494	0.473	0.338	0.261	0.257	0.256	0.250	0.238	0.187	0.170
Upcharge: 08-47-CON	1.470	0.859	0.551	0.523	0.505	0.472	0.466	0.444	0.412	0.383
Aqueous Coating - Flood Gloss, Satin or Matte (on print orders)	FREE	FREE	FREE	FREE	FREE	FREE	FREE	FREE	FREE	FREE
Aqueous Coating - Flood Soft-Touch (on print orders)	1.171	0.654	0.379	0.275	0.223	0.204	0.186	0.127	0.117	0.106
UV Coating - Flood High Gloss	0.497	0.302	0.186	0.161	0.152	0.133	0.124	0.116	0.114	0.102
Lamination - Oversize Gloss	0.629	0.407	0.335	0.296	0.279	0.276	0.274	0.267	0.262	0.262
Lamination - Oversize Matte	0.789	0.624	0.493	0.456	0.436	0.425	0.420	0.408	0.401	0.395
Lamination - Oversize Soft-Touch	0.954	0.717	0.585	0.539	0.518	0.504	0.495	0.477	0.468	0.465

(R) Price shown is per piece

Stock and Foil selections on inside back cover. Please call for pricing on other options not listed.

CAPACITY FOLDERS



08-13 Dark Blue Linen with Metallic Silver, White and Non-Metallic Blue foils

TWO BOX POCKETS

♥ 08-13

Two ¼" capacity box pockets with ½" backbone (shown)

♥ 08-17

Two ⅜" capacity box pockets with ¾" backbone

♥ 08-20

Two ½" capacity box pockets with 1" backbone

Price: base price **plus** upcharge on page 14

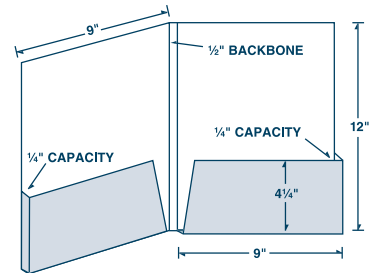

08-53 printed 4CP

REGULAR & BOX POCKET

♥ 08-53

Regular left pocket with ¼" capacity right box pocket

Price: base price **plus** upcharge on page 14

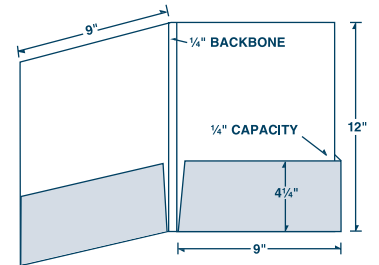

29-82-CON printed 4CP

CONFORMER® RE EDGES TALL POCKETS

29-82-CON

Two 6" tall pockets with reinforced edges – holds up to ⅜" per pocket

Price: base price **plus** upcharge on page 14 – call for pricing if laminating

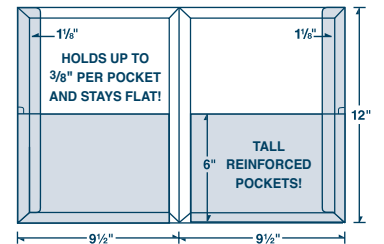

Conformer® is a registered trademark of Conformer® Products. A patent number will be added to Conformer® Products.



29-72 printed 4CP

RE EDGES with TWO EXPANDABLE POCKETS

♥ 28-72

Two ¼" capacity expandable pockets

Price: see page 14 – call for pricing if laminating

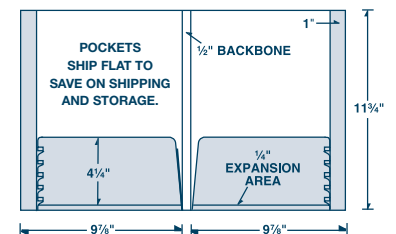

29-86 printed 4CP

RE EDGES FILE TAB with EXPANDABLE POCKET

28-86

Regular left pocket with ¼" expandable right pocket

Price: see page 14

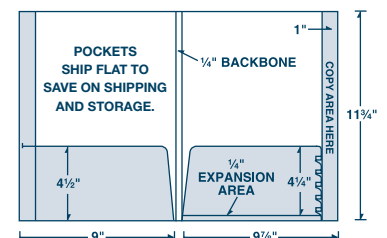

THREE PANEL FOLDERS

Expand your message with extra panels!

A favorite of home builders, medical providers & hospitality industries.

Product Specifications

- Available printed, foil stamped or embossed
- Base stocks included in price – additional charge for other stock groups
- FREE overall GLOSS, SATIN or MATTE aqueous coating on print orders
- A variety of card slots, brochure slits & other pocket options are available FREE – see page 22 or refer to design templates

Production Schedule

- 7 - 10 production days
- Soft-Touch aqueous coating: add 1 production day



THREE POCKETS ♥ 38-01

Price: shown below

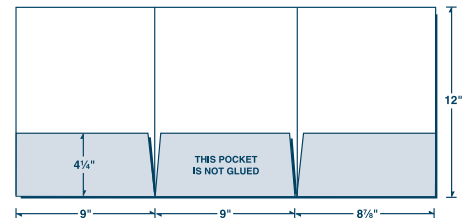

ONE POCKET ♥ 38-04

Right pocket only (shown)

38-03

Unglued center pocket only

Price: shown below

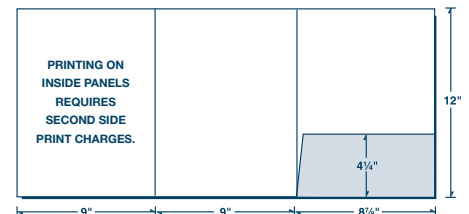

THREE PANEL FOLDERS – BASE STOCK PRICE	250	500	1000	1500	2000	2500	3000	5000	7500	10000
Print One PMS Color - No Heavy Coverage	4.351	2.520	1.457	1.171	1.050	0.976	0.944	0.814	0.788	0.773
Print Two PMS Colors - No Heavy Coverage	4.992	2.870	1.669	1.316	1.177	1.089	1.044	0.879	0.847	0.827
Four Color Process	4.781	2.905	1.726	1.413	1.230	1.110	1.049	0.885	0.843	0.807
Foil Stamp or Emboss - One Area up to 36 sq. in.	4.179	2.777	1.656	1.331	1.265	1.183	1.137	0.966	0.959	0.956
Foil Stamp + Emboss (same copy) - One Area up to 36 sq. in.	5.319	3.407	2.031	1.629	1.519	1.423	1.372	1.167	1.152	1.137
OPTIONS: ADD TO BASE										
Additional PMS Color/Heavy Ink Coverage (per side)	0.642	0.350	0.212	0.145	0.127	0.113	0.100	0.065	0.059	0.054
Four Color Process (2nd side)	2.360	1.022	0.595	0.446	0.384	0.347	0.328	0.253	0.228	0.195
2nd Foil Area - Same Color, Same Side - up to 36 sq. in. (on foil orders)	0.367	0.190	0.105	0.075	0.060	0.050	0.043	0.032	0.023	0.020
Group A Stocks	0.230	0.164	0.144	0.136	0.132	0.130	0.126	0.122	0.118	0.118
Group B Stocks	0.368	0.272	0.240	0.224	0.218	0.212	0.206	0.200	0.194	0.194
Group C Stocks	0.613	0.440	0.388	0.362	0.353	0.342	0.332	0.323	0.312	0.306
Group D Stocks	1.202	0.863	0.761	0.718	0.700	0.680	0.662	0.651	0.639	0.633
Group E Stocks	1.458	1.351	1.283	1.272	1.260	1.248	1.237	1.213	1.202	1.190
Group F Stocks	1.823	1.806	1.753	1.718	1.701	1.683	1.666	1.631	1.613	1.596
Upcharge: 38-08, 38-12	0.843	0.618	0.506	0.468	0.449	0.438	0.431	0.416	0.408	0.405
Aqueous Coating - Flood Gloss, Satin or Matte (on print orders)	FREE	FREE	FREE	FREE	FREE	FREE	FREE	FREE	FREE	FREE
Aqueous Coating - Flood Soft-Touch (on print orders)	1.171	0.654	0.379	0.275	0.223	0.204	0.186	0.127	0.117	0.106
UV Coating - Flood High Gloss	0.647	0.395	0.243	0.209	0.197	0.173	0.162	0.150	0.148	0.131
Lamination - Oversize Gloss	0.735	0.511	0.451	0.414	0.407	0.404	0.400	0.399	0.397	0.397
Lamination - Oversize Matte	1.012	0.876	0.752	0.718	0.700	0.693	0.690	0.683	0.679	0.674
Lamination - Oversize Soft-Touch	1.302	1.085	0.950	0.906	0.885	0.871	0.862	0.844	0.836	0.832

(R) Price shown is per piece

Stock and Foil selections on inside back cover. Please call for pricing on other options not listed.

THREE PANEL FOLDERS



38-05 printed 4CP (4/4)

TWO POCKETS 38-06

Right and center pocket (shown)

38-05

Right and left pocket;
no center pocket

Price: see page 16

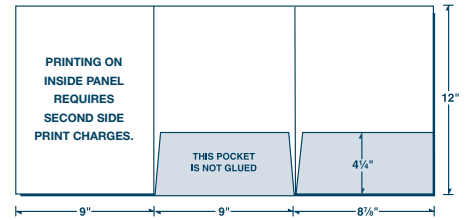

38-53 printed 4CP

UNGLUED FOLDER **NEW** 38-53

Three panel unglued folder
with closure notch

Price: see page 16

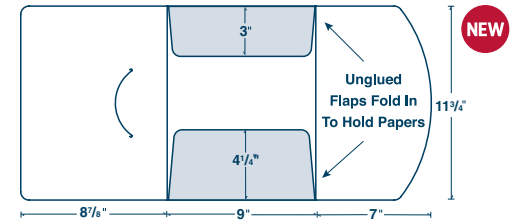

38-82 printed 1PMS
with heavy coverage

TWO TALL POCKETS 38-82

Right and center 6" tall pockets

Price: see page 16

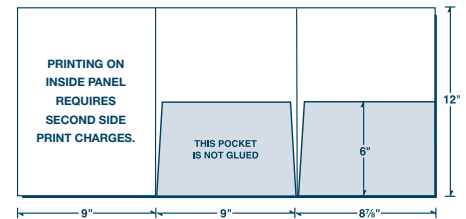

38-08 printed 4CP (4/4)

THREE CURVED POCKETS 38-08

Three unique shaped pockets

Price: base price *plus* upcharge
on page 16

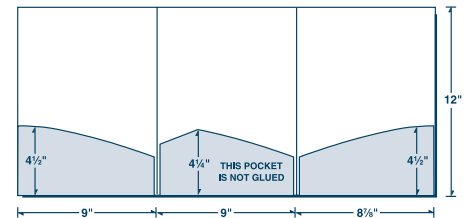

38-12 printed 4CP (4/4)

ONE CENTER BOX POCKET **NEW** 38-12

1/4" capacity box pocket

Price: base price *plus* upcharge
on page 16

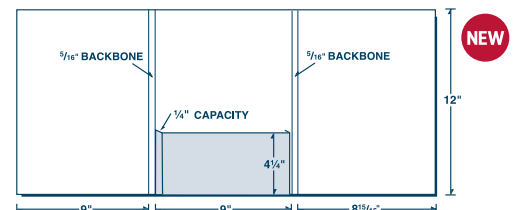

TAX FOLDERS & REPORT COVERS

Covers do MORE for you! Present your proposal, file copy, contract and important documents with style.

Product Specifications

- Available printed, foil stamped or embossed
- Base stocks included in price – additional charge for other stock groups
- FREE overall GLOSS, SATIN or MATTE aqueous coating on print orders
- A variety of card slots are available FREE – see page 22 or refer to design templates
- Spine Attachments can be added to one-piece cover Items 09-28 & 09-29 – see page 22

Production Schedule

- 7 - 10 production days
- Soft-Touch aqueous coating: add 1 production day
- Spine Attachments: add 3 - 5 production days



75-09 printed 1PMS with optional GBC punch (call for price quote)

09-28 printed 4CP plus optional card stock spine attachments see page 22

✔ Like the look of engraving?
A similar look can be achieved by foil stamping plus embossing your imprint. See price below.



75-09 printed 4CP

< 75-01 printed 1PMS

TWO-PIECE COVER 75-01
without window

♥ **75-09**
with window (shown)

Price: shown below

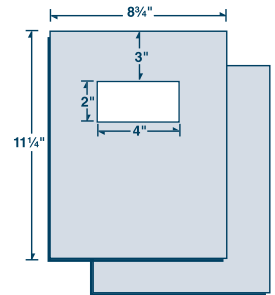

TAX FOLDER & REPORT COVER - BASE STOCK PRICE	250	500	1000	1500	2000	2500	3000	5000	7500	10000
Print One PMS Color - No Heavy Coverage	1.746	0.908	0.600	0.484	0.437	0.412	0.398	0.333	0.295	0.258
Print Two PMS Colors - No Heavy Coverage	2.387	1.258	0.812	0.629	0.564	0.525	0.498	0.398	0.354	0.313
Four Color Process	2.177	1.293	0.868	0.726	0.617	0.547	0.503	0.405	0.350	0.293
Foil Stamp or Emboss - One Area up to 36 sq. in.	1.339	0.862	0.594	0.491	0.481	0.459	0.445	0.377	0.351	0.323
Foil Stamp + Emboss (same copy) - One Area up to 36 sq. in.	2.479	1.492	0.969	0.790	0.734	0.699	0.680	0.578	0.545	0.504
OPTIONS: ADD TO BASE										
Additional PMS Color/Heavy Ink Coverage (per side)	0.642	0.350	0.212	0.145	0.127	0.113	0.100	0.065	0.059	0.054
Four Color Process (2nd side)	1.706	0.871	0.513	0.387	0.319	0.274	0.251	0.195	0.169	0.166
2nd Foil Area - Same Color, Same Side - up to 36 sq. in. (on foil orders)	0.367	0.190	0.105	0.075	0.060	0.050	0.043	0.032	0.023	0.020
Group A Stocks	0.192	0.137	0.120	0.113	0.110	0.108	0.105	0.102	0.098	0.098
Group B Stocks	0.307	0.227	0.200	0.187	0.182	0.177	0.172	0.167	0.162	0.162
Group C Stocks	0.472	0.338	0.298	0.278	0.272	0.263	0.255	0.248	0.240	0.235
Group D Stocks	0.687	0.493	0.435	0.410	0.400	0.388	0.378	0.372	0.365	0.362
Group E Stocks	0.833	0.772	0.733	0.727	0.720	0.713	0.707	0.693	0.687	0.680
Group F Stocks	1.042	1.032	1.002	0.982	0.972	0.962	0.952	0.932	0.922	0.912
Group G Stocks	1.282	1.268	1.232	1.232	1.232	1.232	1.232	1.232	1.232	1.232
Upcharge: 75-36	0.443	0.302	0.302	0.185	0.172	0.168	0.168	0.157	0.127	0.112
Upcharge: 09-36	0.792	0.615	0.463	0.417	0.410	0.402	0.392	0.337	0.320	0.317
Upcharge: 08-36-CON	1.943	1.361	0.902	0.745	0.692	0.664	0.644	0.550	0.481	0.456
Aqueous Coating - Flood Gloss, Satin or Matte (on print orders)	FREE	FREE	FREE	FREE	FREE	FREE	FREE	FREE	FREE	FREE
Aqueous Coating - Flood Soft-Touch (on print orders)	1.171	0.654	0.379	0.275	0.223	0.204	0.186	0.127	0.117	0.106
Spine Attachments (white card stock or matching - see page 22)	0.891	0.876	0.869	0.851	0.847	0.845	0.842	0.836	0.831	0.814

(R) Price shown is per piece

TAX FOLDERS & REPORT COVERS



09-28 Dark Blue Linen with Metallic Silver foil plus optional matching spine attachments

09-29 with window printed 2PMS

ONE-PIECE COVER
09-28
 without window

09-29
 with window (shown)

Price: see page 18

Item ships open, flat

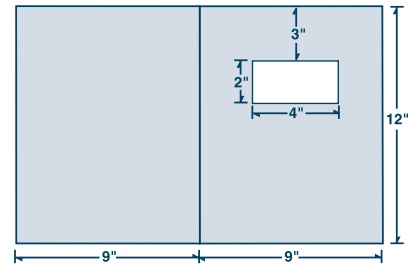

Holes in flap accommodate one or two piece fasteners.

75-36 printed 1PMS in metallic silver ink

75-36 foil stamp + emboss
 Deep Black Linen with Metallic Silver foil

TWO-PIECE CAPACITY COVER

NEW 75-36

Holds up to 1"

Window is optional – request when ordering

Price: base price **plus** upcharge on page 18

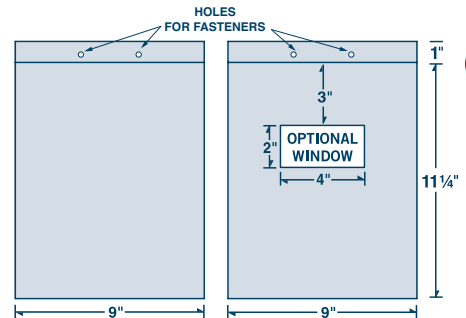

NEW



Holes in flap accommodate one or two piece fasteners.

09-36 foil stamp with optional blind emboss border on Forest Green Hopsack with Metallic Copper foil

ONE-PIECE CAPACITY COVER

NEW 09-36

Holds up to 3/8"

Windows are optional – request when ordering

Window Option A (shown)
 4" x 2" positioned 3" from top

Window Option B
 4 1/4" x 2 3/4" positioned 2 1/2" from top

Price: base price **plus** upcharge on page 18

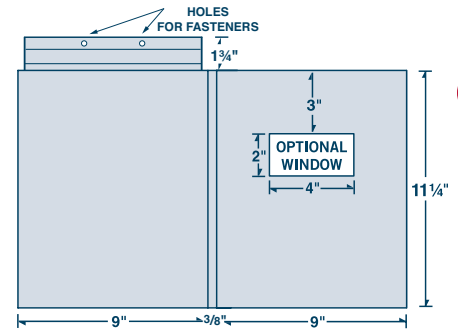

NEW



Holes in flap accommodate one or two piece fasteners.

08-36-CON Burgundy Linen with Platinum foil

CONFORMER® FOLDER with FOLD DOWN TAB

08-36-CON

Holds up to 3/8" per side

Window is optional – request when ordering

Price: base price **plus** upcharge on page 18
 - call for pricing if laminating

✓ Favorite of Accountants & Tax Preparers!

Conformer® is a registered trademark of Conformer® Products. A patent number will be added to Conformer® Products.

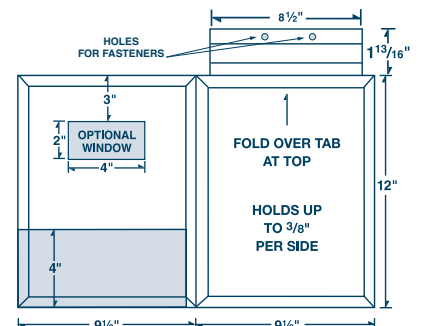

SMALL & MID-SIZE FOLDERS

Good things come in small folders! They'll pack a huge promotional punch, but in a MORE convenient size.

Product Specifications

- Available printed, foil stamped or embossed
- Base stocks included in price – additional charge for other stock groups
- FREE overall GLOSS, SATIN or MATTE aqueous coating on print orders
- Horizontal, notched style card slots are available FREE – see page 22 or refer to design templates

Production Schedule

- 7 - 10 production days
- Soft-Touch aqueous coating: add 1 production day



48-01 printed 2PMS for optional stepped inserts see page 23

< 48-01 printed 4CP for optional stepped inserts see page 23

48-01 Royal Blue Tweed with White foil

4" x 9" FOLDER
♥ **48-01**
Two pockets (shown)

♥ **48-04**
One right pocket only

Price: shown below

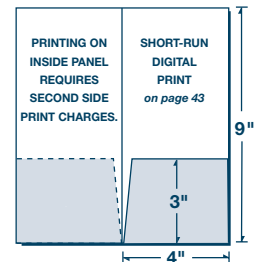

68-01 Merlot Linen with Metallic Gold foil

68-01 printed 4CP

6" x 9" FOLDER
♥ **68-01**
Two pockets (shown)

68-04
One right pocket only

Price: base price **plus** upcharge shown below

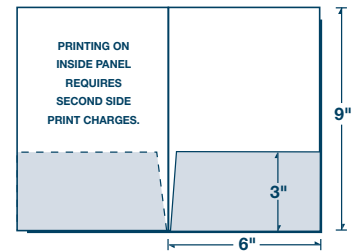

SMALL & MID-SIZE FOLDERS – BASE STOCK PRICE	250	500	1000	1500	2000	2500	3000	5000	7500	10000
Print One PMS Color - No Heavy Coverage	1.487	0.918	0.615	0.538	0.496	0.470	0.449	0.379	0.320	0.267
Print Two PMS Colors - No Heavy Coverage	2.129	1.268	0.826	0.682	0.623	0.583	0.549	0.444	0.378	0.321
Four Color Process	3.722	2.000	1.129	0.868	0.731	0.643	0.580	0.448	0.385	0.335
Foil Stamp or Emboss - One Area up to 36 sq. in.	1.821	1.009	0.684	0.594	0.540	0.525	0.481	0.412	0.353	0.295
Foil Stamp + Emboss (same copy) - One Area up to 36 sq. in.	2.961	1.639	1.059	0.892	0.794	0.765	0.716	0.613	0.546	0.477
OPTIONS: ADD TO BASE										
Additional PMS Color/Heavy Ink Coverage (per side)	0.642	0.350	0.212	0.145	0.127	0.113	0.100	0.065	0.059	0.054
Four Color Process (2nd side)	1.706	0.871	0.513	0.387	0.319	0.274	0.251	0.195	0.169	0.166
2nd Foil Area - Same Color, Same Side - up to 36 sq. in. (on foil orders)	0.367	0.190	0.105	0.075	0.060	0.050	0.043	0.032	0.023	0.020
Group A Stocks	0.058	0.041	0.036	0.034	0.033	0.033	0.032	0.031	0.030	0.030
Group B Stocks	0.104	0.077	0.068	0.064	0.062	0.060	0.058	0.057	0.055	0.055
Group C Stocks	0.165	0.119	0.105	0.098	0.095	0.092	0.089	0.087	0.084	0.082
Group D Stocks	0.275	0.197	0.174	0.164	0.160	0.155	0.151	0.149	0.146	0.145
Group E Stocks	0.333	0.309	0.293	0.291	0.288	0.285	0.283	0.277	0.275	0.272
Group F Stocks	0.417	0.413	0.401	0.393	0.389	0.385	0.381	0.373	0.369	0.365
Upcharge: 48-10, 48-34	0.330	0.221	0.218	0.214	0.212	0.212	0.210	0.200	0.196	0.180
Upcharge: 68-01, 68-04, 68-05, 68-06, 68-07, 68-34, 68-65-CON	0.308	0.207	0.203	0.200	0.198	0.198	0.197	0.187	0.183	0.168
Aqueous Coating - Flood Gloss, Satin or Matte (on print orders)	FREE	FREE	FREE	FREE	FREE	FREE	FREE	FREE	FREE	FREE
Aqueous Coating - Flood Soft-Touch (on print orders)	1.171	0.654	0.379	0.275	0.223	0.204	0.186	0.127	0.117	0.106

(R) Price shown is per piece

SMALL & MID-SIZE FOLDERS



48-10 printed 4CP

48-10 >
Dark Blue Linen
with Copper foil
and sculptured
emboss



< 48-10
printed 2PMS

4½" x 9½" ANGLED POCKETS 48-10

Two deeper, angled pockets

Price: base price **plus** upcharge
on page 20

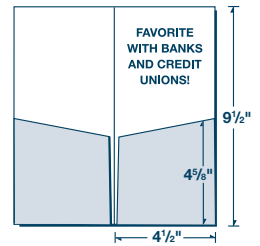

68-07 printed 4CP
for optional stepped
inserts see page 23



< 68-07
Eco Brown Kraft
printed 1PMS
with Metallic Lime foil

7" x 10" MID-SIZE ♥ 68-07

Two pockets

Price: base price **plus** upcharge
on page 20

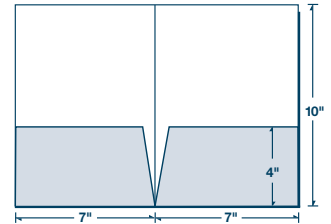

68-06 printed 4CP (4/4)
for optional stepped inserts see page 23

10" x 7" MID-SIZE LANDSCAPE 68-06

One right pocket only

Price: base price **plus** upcharge
on page 20

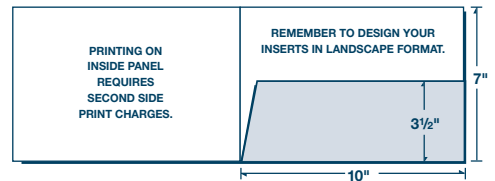

68-05 printed 4CP (4/4)

6" x 11¼" MID-SIZE 68-05

One right pocket only

Price: base price **plus** upcharge
on page 20

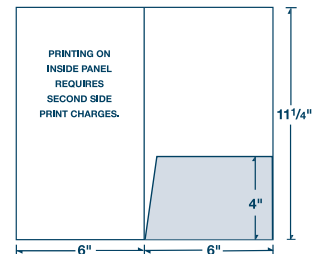

48-34 printed 4CP (4/4)

68-34 printed 4CP (4/4)

4" x 9" and 6" x 9" THREE PANEL 48-34 4" x 9" (shown)

One 3" right pocket only

68-34 6" x 9"

One 3" right pocket only

Price: base price **plus** upcharge
on page 20

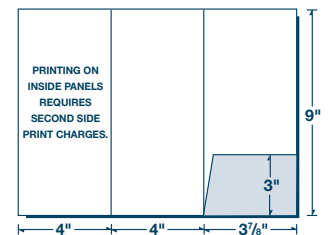

68-65-CON printed 4CP
with Metallic Gold foil

MID-SIZE CONFORMER® NEW 68-65-CON

Holds up to ⅜" per pocket

Price: base price **plus** upcharge
on page 20

Conformer® is a registered trademark of Conformer® Products.
A patent number will be added to Conformer® Products.

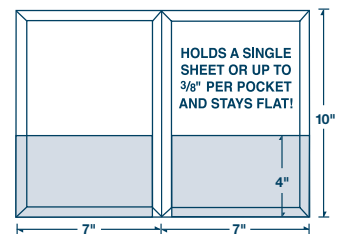

NEW

CARD SLOTS & MORE

Make your product **MORE** functional! Refer to design templates to see **FREE** slots/slits unique to that item.

✓ **Need Business Cards or Brochures?**
See pages 44 & 45



BUSINESS CARD SLOTS (Holds a standard 3½" x 2" business card)

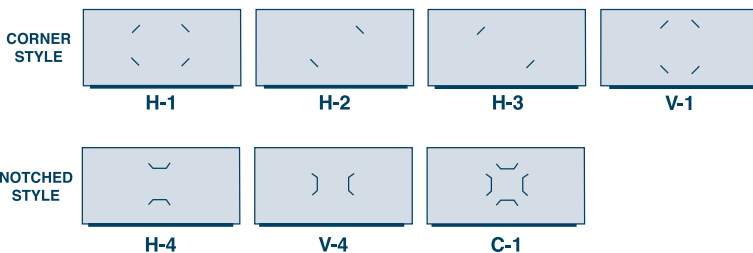

BROCHURE SLITS

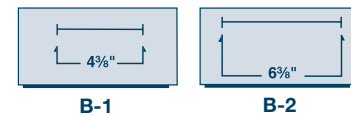

On most products, Brochure Slits are positioned:

- 7/8" down on 4¼" pockets
- 1" down on 4½" pockets
- ¾" down on 4" pockets

FLASH DRIVE SLITS (Use with "stick style" drives)

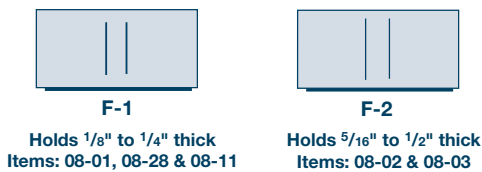

- Functions as a temporary carrier – no permanent protection
- Added to the **RIGHT POCKET** of the items listed

DISC SLIT

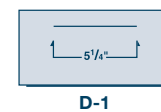

On most products, Disc Slit is positioned:

- 7/8" down on 4¼" pockets
- 1" down on 4½" pockets
- ¾" down on 4" pockets

SPINE ATTACHMENTS

- Stitched into the center score of most standard size folders or one-piece covers
- Holds 8½" x 11" 3-hole punched sheets
- Holds approximately 25 sheets
- Standard in white card stock
- **MATCHING** attachments available in most of our standard stock colors
- Indicate your choice when ordering – see price tables for additional charge – add 3-5 production days

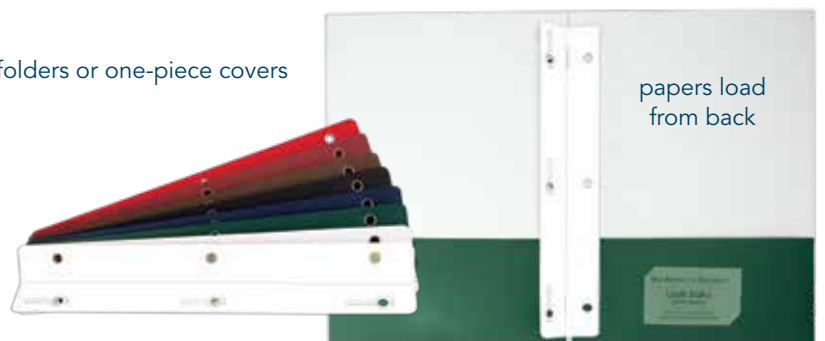

INSERTS

4-Page Stitched Insert and Stepped Inserts



Complete your package by adding stitched or stepped inserts to your folder.

STITCHED INSERTS

- Price includes stitching into folder or cover
- Available in 4, 8, 12 or 16 page counts in Four color process or PMS printing
- Pricing shown for a 4-page insert – call for other options
- Standard sizes are 8½" x 11" or 8⅞" x 11⅞"
- Choose from 80 lb. white C2S gloss or matte text – additional charge for 100 lb. white gloss or matte text

Production Schedule

- Add 3 – 5 production days to folder/cover production



Stepped Inserts

STEPED INSERTS

- Price includes printing in any location on the FRONT SIDE of each insert
- PMS pricing does not include heavy coverage
- Available in a variety of sizes
- Choose from 80 lb. white C2S gloss or matte text – additional charge for 100 lb. white gloss or matte text

Production Schedule

- 7-10 production days
- Collating & inserting: add 3 - 5 production days

NEW 100 lb. Matte Text now available!

4-PAGE STITCHED INSERT - Presentation Folders or Covers	250	500	1000	1500	2000	2500	3000	5000	7500	10000
4-PAGE (add cost to folder price - includes stitching insert into item)										
Print One PMS Color	2.387	1.365	0.893	0.715	0.618	0.575	0.542	0.477	0.472	0.412
Print Two PMS Colors	2.387	1.365	0.893	0.715	0.618	0.575	0.542	0.477	0.472	0.412
Four Color Process	4.327	2.277	1.297	0.962	0.817	0.715	0.667	0.570	0.512	0.462
100 lb. Gloss or Matte Text Upcharge	0.072	0.072	0.055	0.055	0.055	0.055	0.055	0.055	0.055	0.055
Aqueous Coating - Flood Gloss, Satin or Matte	FREE	FREE	FREE	FREE	FREE	FREE	FREE	FREE	FREE	FREE

(R) Price shown is per piece

STEPED INSERT PRICES - Sets for Small Presentation Folders (Up to 5 inserts)	250	500	1000	1500	2000	2500	3000	5000	7500	10000
12-00 (4" x 9")										
Print One PMS Color - No Heavy Coverage	1.857	0.997	0.553	0.405	0.332	0.287	0.257	0.198	0.168	0.153
Print Two PMS Colors - No Heavy Coverage	2.613	1.383	0.753	0.545	0.440	0.377	0.335	0.252	0.210	0.188
Four Color Process	2.802	1.532	0.860	0.637	0.525	0.458	0.413	0.323	0.278	0.257
100 lb. Gloss or Matte Text Upcharge	0.037	0.037	0.027	0.027	0.027	0.027	0.027	0.027	0.027	0.027
Collating Upcharge	0.127	0.082	0.077	0.077	0.077	0.077	0.077	0.077	0.077	0.077
Inserting Upcharge	0.145	0.145	0.110	0.097	0.093	0.087	0.085	0.073	0.060	0.055

(R) Price shown is per set

STEPED INSERT PRICES - Sets for Large Presentation Folders (Up to 4 inserts)	250	500	1000	1500	2000	2500	3000	5000	7500	10000
12-00 (8½" wide)										
Four Color Process 1 insert	0.487	0.260	0.142	0.110	0.097	0.093	0.082	0.065	0.058	0.053
Four Color Process 2 inserts	0.973	0.520	0.285	0.222	0.193	0.185	0.163	0.128	0.118	0.108
Four Color Process 3 inserts	1.467	0.780	0.427	0.332	0.288	0.278	0.245	0.193	0.177	0.162
Four Color Process 4 inserts	1.960	1.040	0.570	0.442	0.385	0.370	0.328	0.258	0.235	0.217
100 lb. Gloss or Matte Text Upcharge	0.037	0.037	0.027	0.027	0.027	0.027	0.027	0.027	0.027	0.027
Collating Upcharge	0.110	0.065	0.060	0.060	0.060	0.060	0.060	0.060	0.060	0.060
Inserting Upcharge	0.145	0.145	0.110	0.097	0.093	0.087	0.085	0.073	0.060	0.055

(R) Price shown is per set

Please call for pricing on other options not listed.

CERTIFICATE COVERS

Give credit where credit is due! Present certificates in a stylish cover and add MORE to the achievement.

Product Specifications

- Available printed, foil stamped or embossed
- Holds 8½" x 11" certificates
- Optional slits to hold 8" x 10" photo available upon request
- Base stocks included in price – additional charge for other stock groups

Production Schedule

- Foil Stamp: 5 production days
- Foil Stamp + Emboss: 7 production days
- Printing: 7 production days



09-11 foil stamp + emboss
Deep Black Linen with Metallic Gold foil

09-11 printed 4CP

09-11 Red Hopsack with
Metallic Gold foil

CERTIFICATE COVER

♥ 09-11

Letter Size (shown)

Price: shown below

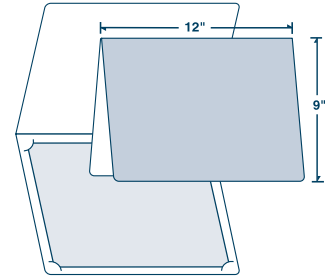

✓ Need a Legal Size cover? Request a quote for Item 09-14



09-10 Burgundy Linen
with Metallic Gold foil

< 09-10 Deep Pine Linen
with Metallic Gold foil

PORTFOLIO CERTIFICATE COVER 09-10

Price: base price **plus** upcharge
shown below

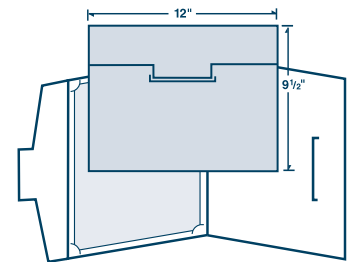

09-16 Dark Blue Linen
with Metallic Silver foil

< 09-16 Deep Black Linen
with Metallic Silver foil

FOLD-UP with CLOSURE NOTCH 09-16

Price: base price **plus** upcharge
shown below

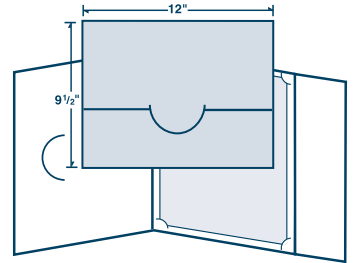

✓ Great item for round logos or seals!

CERTIFICATE COVERS - BASE STOCK PRICE	250	500	1000	1500	2000	2500	3000	5000	7500	10000
Print One PMS Color - No Heavy Coverage	1.746	0.908	0.600	0.484	0.437	0.412	0.398	0.333	0.295	0.258
Print Two PMS Colors - No Heavy Coverage	2.387	1.258	0.812	0.629	0.564	0.525	0.498	0.398	0.354	0.313
Four Color Process	2.177	1.293	0.868	0.726	0.617	0.547	0.503	0.405	0.350	0.293
Foil Stamp or Emboss - One Area up to 36 sq. in.	1.339	0.862	0.594	0.491	0.481	0.459	0.445	0.377	0.351	0.323
Foil Stamp + Emboss (same copy) - One Area up to 36 sq. in.	2.479	1.492	0.969	0.790	0.734	0.699	0.680	0.578	0.545	0.504
OPTIONS: ADD TO BASE										
Additional PMS Color/Heavy Ink Coverage (per side)	0.642	0.350	0.212	0.145	0.127	0.113	0.100	0.065	0.059	0.054
2nd Foil Area - Same Color, Same Side - up to 36 sq. in. (on foil orders)	0.367	0.190	0.105	0.075	0.060	0.050	0.043	0.032	0.023	0.020
Group A Stocks	0.192	0.137	0.120	0.113	0.110	0.108	0.105	0.102	0.098	0.098
Group B Stocks	0.307	0.227	0.200	0.187	0.182	0.177	0.172	0.167	0.162	0.162
Group C Stocks	0.472	0.338	0.298	0.278	0.272	0.263	0.255	0.248	0.240	0.235
Group D Stocks	0.687	0.493	0.435	0.410	0.400	0.388	0.378	0.372	0.365	0.362
Group E Stocks	0.833	0.772	0.733	0.727	0.720	0.713	0.707	0.693	0.687	0.680
Group F Stocks	1.042	1.032	1.002	0.982	0.972	0.962	0.952	0.932	0.922	0.912
Group G Stocks	1.282	1.268	1.232	1.232	1.232	1.232	1.232	1.232	1.232	1.232
Upcharge: 09-10, 09-16	0.110	0.110	0.092	0.092	0.092	0.092	0.092	0.092	0.092	0.092
Aqueous Coating - Flood Gloss, Satin or Matte (on print orders)	FREE	FREE	FREE	FREE	FREE	FREE	FREE	FREE	FREE	FREE

(R) Price shown is per piece

Stock and Foil selections on inside back cover. Please call for pricing on other options not listed.

A simple but cool way to hand out pages.

Product Specifications

- Available plain, printed, foil stamped or embossed
- Pocket glued at both sides
- Holds 8½" x 11" papers
- Limited card slot styles are available FREE - refer to design templates
- Base stocks included in price – additional charge for other stock groups

Production Schedule

- 7-10 production days

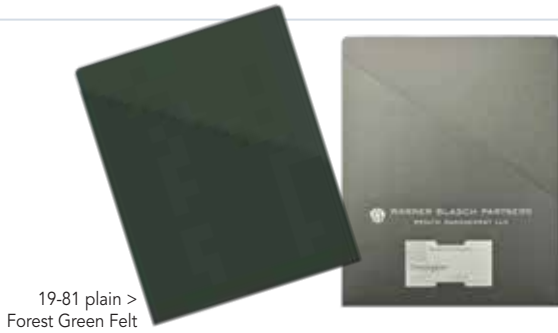

< 19-81 Charcoal Grandee with White foil

19-81 plain > Forest Green Felt

ANGLED POCKET PAGE

NEW 19-81

Holds approximately 15 sheets

Price: shown below

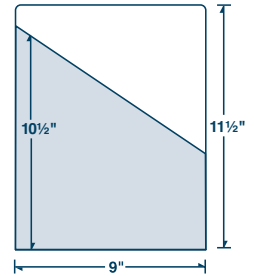

< 19-80 Merlot Linen with Metallic Gold foil

19-80 Dark Blue Linen > with Metallic Silver foil

WAVY POCKET PAGE

NEW 19-80

Holds approximately 15 sheets

Price: shown below

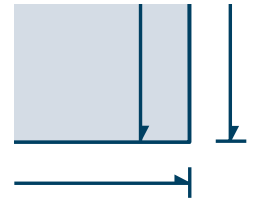

< 19-65-CON printed 4CP

CONFORMER® POCKET PAGE

NEW 19-65-CON

Holds approximately 50 sheets

Price: base price **plus** upcharge shown below

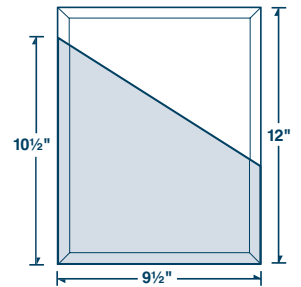

Conformer® is a registered trademark of Conformer® Products. A patent number will be added to Conformer® Products.

POCKET PAGES - BASE STOCK PRICE	250	500	1000	1500	2000	2500	3000	5000	7500	10000
Plain	2.553	1.447	0.952	0.823	0.744	0.707	0.692	0.580	0.530	0.490
Print One PMS Color - No Heavy Coverage	3.195	1.797	1.164	0.968	0.871	0.820	0.792	0.645	0.589	0.544
Print Two PMS Colors - No Heavy Coverage	3.836	2.147	1.376	1.113	0.998	0.933	0.892	0.710	0.648	0.598
Four Color Process	3.626	2.182	1.433	1.211	1.051	0.955	0.897	0.716	0.644	0.578
Foil Stamp or Emboss - One Area up to 36 sq. in.	2.788	1.750	1.158	0.976	0.915	0.867	0.838	0.688	0.645	0.609
Foil Stamp + Emboss (same copy) - One Area up to 36 sq. in.	3.928	2.380	1.533	1.274	1.169	1.107	1.073	0.890	0.838	0.790
OPTIONS: ADD TO BASE										
Additional PMS Color/Heavy Ink Coverage (per side)	0.642	0.350	0.212	0.145	0.127	0.113	0.100	0.065	0.059	0.054
2nd Foil Area - Same Color, Same Side - up to 36 sq. in. (on foil orders)	0.367	0.190	0.105	0.075	0.060	0.050	0.043	0.032	0.023	0.020
Group A Stocks	0.192	0.137	0.120	0.113	0.110	0.108	0.105	0.102	0.098	0.098
Group B Stocks	0.307	0.227	0.200	0.187	0.182	0.177	0.172	0.167	0.162	0.162
Group C Stocks	0.472	0.338	0.298	0.278	0.272	0.263	0.255	0.248	0.240	0.235
Group D Stocks	0.687	0.493	0.435	0.410	0.400	0.388	0.378	0.372	0.365	0.362
Group E Stocks	0.833	0.772	0.733	0.727	0.720	0.713	0.707	0.693	0.687	0.680
Group F Stocks	1.042	1.032	1.002	0.982	0.972	0.962	0.952	0.932	0.922	0.912
Group G Stocks	1.282	1.268	1.232	1.232	1.232	1.232	1.232	1.232	1.232	1.232
Upcharge: 19-65-CON	0.339	0.205	0.184	0.182	0.173	0.154	0.136	0.101	0.078	0.069
Aqueous Coating - Flood Gloss, Satin or Matte (on print orders)	FREE	FREE	FREE	FREE	FREE	FREE	FREE	FREE	FREE	FREE

(R) Price shown is per piece

Stock and Foil selections on inside back cover. Please call 901.569.0110 for pricing on other options not listed.

FILE FOLDERS

Save **MORE** time with custom file folders! Avoid missing information by adding a useful form to your file folder.

Product Specifications

- One or two PMS ink color(s)
 - Front & back cover (one side of the sheet)
 - No heavy ink coverage; max. 35% ink coverage
- Four color process
 - 12 PT C1S Semi-gloss stock recommended
 - FREE overall GLOSS, SATIN or MATTE aqueous coating applied on Semi-gloss orders

Production Schedule

- 7 production days
- Item 35-13 production time varies, based on quantity

Stock Choices

				
150 lb. Tag White 30% ♀ ▲	150 lb. Tag Manila ▲	140 lb. Index Canary ▲	140 lb. Index Blue ▲	12 PT C1S Semi-gloss



09-24-001 printed 1PMS



35-13 printed 2PMS + heavy coverage



16-03 printed 4CP >

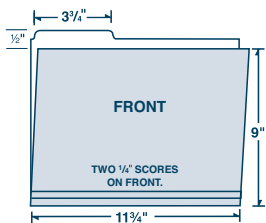

LETTER SIZE FILE FOLDER

- ♥ 09-24-001
- 1st position (left) tab, shown
- ♥ 09-24-002
- 2nd position (center) tab
- ♥ 09-24-003
- 3rd position (right) tab

Price: shown below

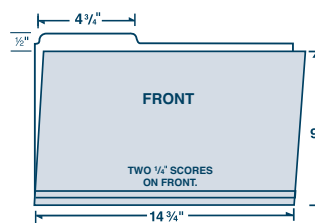

LEGAL SIZE FILE FOLDER

- ♥ 09-25-001
- 1st position (left) tab, shown
- ♥ 09-25-002
- 2nd position (center) tab
- ♥ 09-25-003
- 3rd position (right) tab

Price: base price **plus** upcharge shown below

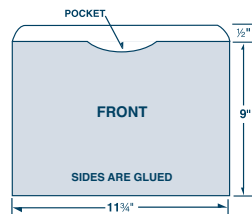

FILE JACKET

- ♥ 16-03
- Top tab is not reinforced; sides are glued

Price: base price **plus** upcharge shown below

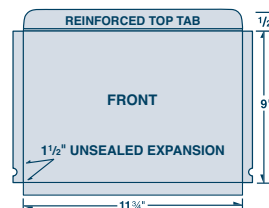

EXPANSION FILE FOLDER

- 35-13
- 1 1/2" unsealed expansion

Ships flat with gusset out; sides are glued – reinforced top tab is included in front side print charge

Price: base price **plus** upcharge shown below

FILE FOLDER BASE PRICE - Your choice of the stocks listed above.	250	500	1000	1500	2000	2500	3000	5000	7500	10000
Print One PMS Color - No Heavy Coverage	1.937	1.045	0.720	0.597	0.547	0.520	0.503	0.435	0.394	0.357
Print Two PMS Colors - No Heavy Coverage	2.579	1.395	0.932	0.742	0.674	0.633	0.603	0.500	0.452	0.411
Four Color Process	2.368	1.430	0.988	0.840	0.727	0.655	0.608	0.506	0.449	0.391
OPTIONS: ADD TO BASE										
Additional PMS Color/Heavy Ink Coverage (per side)	0.642	0.350	0.212	0.145	0.127	0.113	0.100	0.065	0.059	0.054
Upcharge: Legal Size 09-25-XXX	0.189	0.150	0.141	0.132	0.114	0.106	0.095	0.066	0.057	0.051
Upcharge: 16-03	1.791	1.071	0.712	0.610	0.606	0.537	0.468	0.350	0.323	0.306
Upcharge: 35-13	2.334	1.553	1.124	0.985	0.981	0.909	0.838	0.715	0.688	0.669
Aqueous Coating - Flood Gloss, Satin or Matte (on semi-gloss stock)	FREE	FREE	FREE	FREE	FREE	FREE	FREE	FREE	FREE	FREE

(R) Price shown is per piece

Please call for pricing on other options not listed.

KEY & CARD HOLDERS

Present *MORE* info with every card! Add helpful phone numbers, restaurant hours, car rental, local attractions, travel tips, etc.

Product Specifications

- Available printed, foil stamped or embossed
- Holds a standard 3³/₈" x 2¹/₈" card (CR80 credit card size)
- Base stocks included in price – additional charge for other stock groups
- FREE overall GLOSS, SATIN or MATTE aqueous coating on print orders

Production Schedule

- 7 - 10 production days



✓ Choosing a stock?
We recommend no stock heavier than 12 PT or 80 LB.

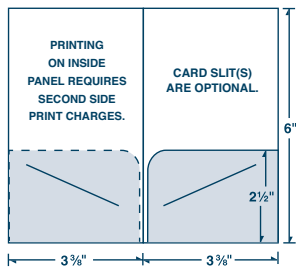

HOTEL KEY or CARD HOLDER
27-09
Two pockets (shown)
♥ **27-11**
One right pocket only
Price: shown below

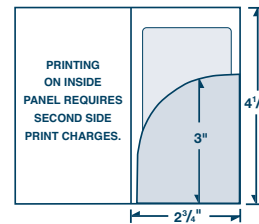

ONE CURVED POCKET CARD HOLDER
♥ **27-05**
Price: shown below

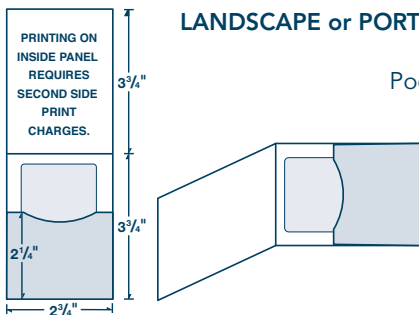

LANDSCAPE or PORTRAIT CARD HOLDER
♥ **27-04**
Pocket glued both sides
Price: shown below

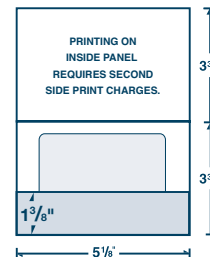

CARD HOLDER
27-03
Pocket glued both sides
Price: shown below

KEY & CARD HOLDERS - BASE STOCK PRICE	1000	1500	2000	2500	3000	5000	7500	10000
Print One PMS Color - No Heavy Coverage	0.535	0.487	0.442	0.401	0.390	0.266	0.252	0.214
Print Two PMS Colors - No Heavy Coverage	0.711	0.615	0.546	0.491	0.438	0.305	0.289	0.251
Four Color Process	1.391	1.037	0.830	0.695	0.629	0.418	0.358	0.314
Foil Stamp or Emboss - One Area up to 25 sq. in.	0.790	0.572	0.458	0.400	0.408	0.292	0.278	0.244
OPTIONS: ADD TO BASE								
Additional PMS Color/Heavy Ink Coverage (per side)	0.176	0.128	0.104	0.090	0.048	0.039	0.037	0.037
Group A Stocks	0.036	0.034	0.033	0.033	0.032	0.031	0.030	0.030
Group B Stocks	0.068	0.064	0.062	0.060	0.058	0.057	0.055	0.055
Group C Stocks	0.105	0.098	0.095	0.092	0.089	0.087	0.084	0.082
Group D Stocks	0.174	0.164	0.160	0.155	0.151	0.149	0.146	0.145
Group E Stocks	0.293	0.291	0.288	0.285	0.283	0.277	0.275	0.272
Aqueous Coating - Flood Gloss, Satin or Matte (on print orders)	FREE	FREE	FREE	FREE	FREE	FREE	FREE	FREE

(R) Price shown is per piece

Stock and Foil selections on inside back cover. Please call for pricing on other options not listed.

PHOTO HOLDERS

Make it an event to remember with custom imprinted photo holders!
Great for fundraisers, fashion shows, golf outings & more!

Product Specifications

- Available printed, foil stamped or embossed
- Base stocks included in price – additional charge for other stock groups
- FREE overall GLOSS, SATIN or MATTE aqueous coating on print orders

Production Schedule

- 10 production days



03-05 Deep Pine Linen with Metallic Silver foil



03-05 printed 1PMS (1/1)

LANDSCAPE
HOLDS 6" x 4" PHOTO
♥ 03-05

Price: base price *plus* upcharge shown below

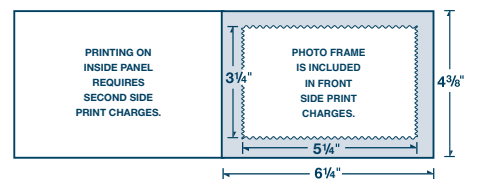

< 03-03 Red Hopsack with Metallic Gold foil



< 03-03 printed 4CP

PORTRAIT
HOLDS 4" x 6" PHOTO
03-03

Price: shown below

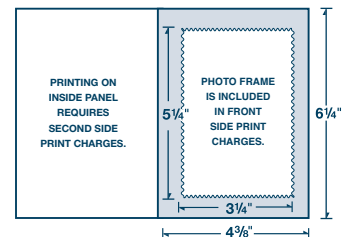

PHOTO HOLDERS - BASE STOCK PRICE	150	250	500	1000	1500	2000	2500	3000	5000
Print One PMS Color - No Heavy Coverage	3.317	2.246	1.383	1.105	0.918	0.853	0.832	0.803	0.742
Print Two PMS Colors - No Heavy Coverage	4.383	2.888	1.733	1.317	1.062	0.980	0.945	0.903	0.807
Four Color Process	8.917	5.626	3.055	1.734	1.354	1.141	1.029	0.939	0.827
Foil Stamp or Emboss - One Area up to 36 sq. in.	2.542	1.839	1.337	1.099	0.925	0.897	0.879	0.850	0.785
Foil Stamp + Emboss (same copy) - One Area up to 36 sq. in.	4.208	2.979	1.967	1.474	1.224	1.151	1.119	1.085	0.987
OPTIONS: ADD TO BASE									
Additional PMS Color/Heavy Ink Coverage (per side)	1.067	0.642	0.350	0.212	0.145	0.127	0.113	0.100	0.065
Group A Stocks	0.250	0.192	0.137	0.120	0.113	0.110	0.108	0.105	0.102
Group B Stocks	0.393	0.307	0.227	0.200	0.187	0.182	0.177	0.172	0.167
Group C Stocks	0.610	0.472	0.338	0.298	0.278	0.272	0.263	0.255	0.248
Group D Stocks	0.890	0.687	0.493	0.435	0.410	0.400	0.388	0.378	0.372
Group E Stocks	0.980	0.833	0.772	0.733	0.727	0.720	0.713	0.707	0.693
Group F Stocks	1.127	1.042	1.032	1.002	0.982	0.972	0.962	0.952	0.932
Upcharge: 03-05	0.105	0.070	0.070	0.070	0.070	0.070	0.070	0.070	0.070
Upcharge: 03-07, 03-08, 03-12	0.354	0.213	0.213	0.213	0.213	0.213	0.213	0.213	0.213
Upcharge: 03-09, 03-10	0.707	0.421	0.359	0.299	0.297	0.290	0.280	0.264	0.263
Aqueous Coating - Flood Gloss, Satin or Matte (on print orders)	FREE	FREE	FREE	FREE	FREE	FREE	FREE	FREE	FREE

(R) Price shown is per piece

Stock and Foil selections on inside back cover. Please call for pricing on other options not listed.

PHOTO HOLDERS

03-07 printed 2PMS



PORTRAIT - HOLDS 5" x 7" PHOTO
♥ 03-07

Price: base price *plus* upcharge on page 28

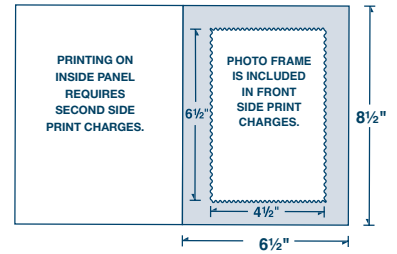

< 03-07 printed 4CP

LANDSCAPE - HOLDS 7" x 5" PHOTO
♥ 03-08

Price: base price *plus* upcharge on page 28



< 03-08 printed 4CP (4/4)

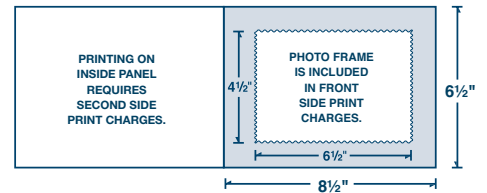

LANDSCAPE HOLDS 8" x 6" PHOTO
NEW 03-12

Price: base price *plus* upcharge on page 28



03-12 printed 4CP

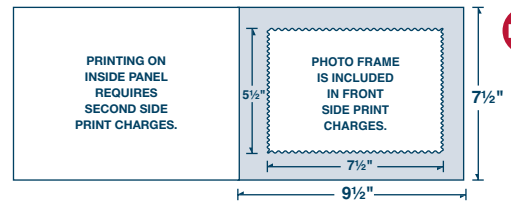

NEW

PORTRAIT HOLDS 8" x 10" PHOTO
03-09

Price: base price *plus* upcharge on page 28

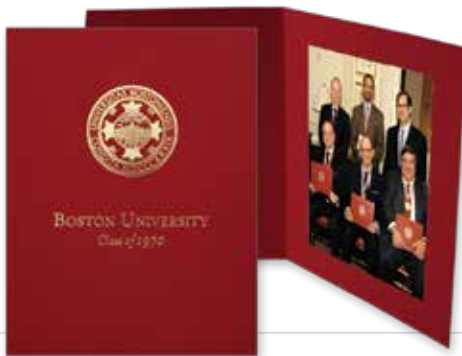

< 03-09 Burgundy Linen with Metallic Gold foil

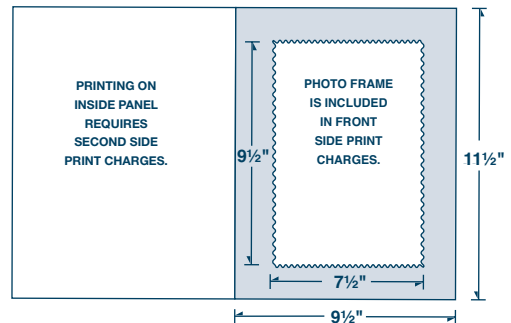

< 03-10 Dark Blue Linen with Metallic Gold foil

< 03-10 printed 4CP

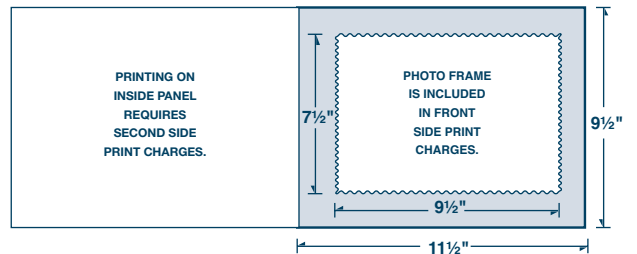

LANDSCAPE - HOLDS 10" x 8" PHOTO
03-10

Price: base price *plus* upcharge on page 28

PORTFOLIOS

If you have odd size materials or just need MORE expansion capabilities...you need a Portfolio!

Product Specifications

- Available printed, foil stamped or embossed
- Base stocks included in price – additional charge for other stock groups
- FREE overall GLOSS, SATIN or MATTE aqueous coating on print orders
- Hook-and-loop or elastic band closures (black or white) can be added for an additional charge – a small hole is added to the flap to anchor the elastic band
- Card slots are available on some portfolio styles – refer to design template

Production Schedule

- UNSEALED expansion portfolios: 10 production days
- Mailers, SEALED expansion portfolios: 10 - 15 production days
- Velcro application: requires additional production time
- Soft-Touch aqueous coating: add 1 production day



✓ UNSEALED expansion gussets take less time to produce and are budget friendly — but the corners are open.

The corners on SEALED expansion gussets are closed.

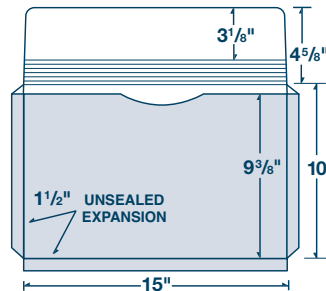

10" x 15" EXPANSION

♥ 35-11
1 1/2" UNSEALED expansion gusset (shown)

♥ 35-01
1 1/2" SEALED expansion gusset

Price: base price **plus** upcharge below

PORTFOLIOS – BASE STOCK PRICE	250	500	1000	1500	2000	2500	3000	5000	7500	10000
Print One PMS Color - No Heavy Coverage	3.764	2.148	1.450	1.215	1.169	1.073	0.989	0.799	0.730	0.675
Print Two PMS Colors - No Heavy Coverage	4.406	2.498	1.661	1.360	1.296	1.186	1.089	0.864	0.789	0.729
Four Color Process	4.195	2.533	1.718	1.458	1.349	1.208	1.094	0.871	0.785	0.709
Foil Stamp or Emboss - One Area up to 36 sq. in.	3.357	2.102	1.444	1.223	1.213	1.120	1.035	0.843	0.786	0.739
Foil Stamp + Emboss (same copy) - One Area up to 36 sq. in.	4.497	2.732	1.819	1.521	1.466	1.360	1.270	1.044	0.980	0.921
OPTIONS: ADD TO BASE										
Additional PMS Color/Heavy Ink Coverage (per side)	0.642	0.350	0.212	0.145	0.127	0.113	0.100	0.065	0.059	0.054
2nd Foil Area - Same Color, Same Side - up to 36 sq. in. (on foil orders)	0.367	0.190	0.105	0.075	0.060	0.050	0.043	0.032	0.023	0.020
Group A Stocks	0.192	0.137	0.120	0.113	0.110	0.108	0.105	0.102	0.098	0.098
Group B Stocks	0.307	0.227	0.200	0.187	0.182	0.177	0.172	0.167	0.162	0.162
Group C Stocks	0.472	0.338	0.298	0.278	0.272	0.263	0.255	0.248	0.240	0.235
Group D Stocks	0.687	0.493	0.435	0.410	0.400	0.388	0.378	0.372	0.365	0.362
Group E Stocks	0.833	0.772	0.733	0.727	0.720	0.713	0.707	0.693	0.687	0.680
Group F Stocks	1.042	1.032	1.002	0.982	0.972	0.962	0.952	0.932	0.922	0.912
Group G Stocks	1.282	1.268	1.232	1.232	1.232	1.232	1.232	1.232	1.232	1.232
Upcharge: 16-11-CON, 16-12-CON, 16-45-CON	0.770	0.486	0.335	0.274	0.251	0.231	0.217	0.187	0.166	0.164
Upcharge: 16-13-CON, 16-14-CON, 16-44-CON	0.344	0.194	0.126	0.102	0.097	0.095	0.090	0.078	0.062	0.060
Upcharge: 35-01, 35-02, 35-04	1.112	1.109	0.999	0.901	0.899	0.880	0.880	0.880	0.880	0.880
Upcharge: 35-11, 35-12	0.468	0.434	0.378	0.339	0.339	0.339	0.339	0.339	0.339	0.339
Aqueous Coating - Flood Gloss, Satin or Matte (on print orders)	FREE	FREE	FREE	FREE	FREE	FREE	FREE	FREE	FREE	FREE
Aqueous Coating - Flood Soft-Touch (on print orders)	1.171	0.654	0.379	0.275	0.223	0.204	0.186	0.127	0.117	0.106
Hook-and-Loop Closures (white or black)	0.666	0.517	0.443	0.410	0.399	0.390	0.387	0.376	0.371	0.369
Elastic Band Closures (white or black)	0.364	0.364	0.364	0.364	0.364	0.364	0.364	0.364	0.364	0.364

(R) Price shown is per piece

Stock and Foil selections on inside back cover. Please call for pricing on other options not listed.

PORTFOLIOS

35-12 printed 1PMS



35-02 printed 4CP >
pictured with optional tab dividers
and white hook and loop closure

9" x 12" EXPANSION
35-12

1½" UNSEALED expansion gusset (shown)

♥ **35-02**

1½" SEALED expansion gusset (photo at left)

NEW **35-04**

2" SEALED expansion gusset

Price: base price **plus** upcharge
on page 30

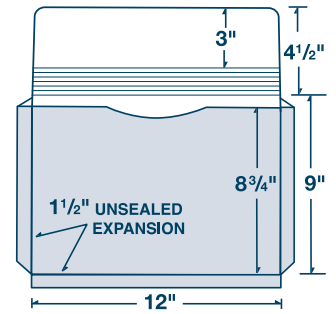

< 16-01 printed 4CP
pictured with optional
elastic band closure



16-01 printed 4CP >

10" x 15" DELUXE
♥ **16-01**

10" x 15" closed (shown)

16-02

10" x 13" closed

Price: see page 30

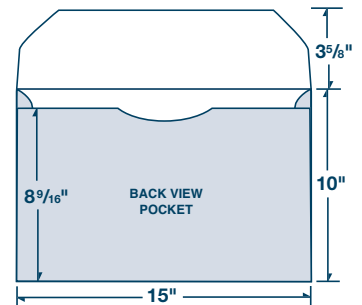

16-12-CON printed 4CP

CONFORMER® CAPACITY MAILER

♥ **16-12-CON**

10½" x 12¾" with 1" capacity
(shown)

16-11-CON

courier size

9¾" x 12¼" with ¾" capacity

16-45-CON

legal size

10¼" x 15" with ¾" capacity

Price: base price **plus** upcharge
on page 30

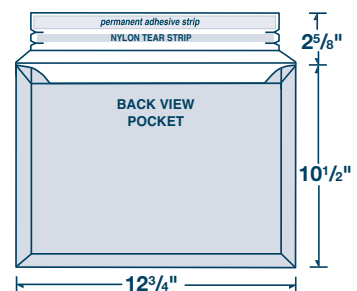

Conformer® is a registered trademark of Conformer® Products. A patent number will be added to Conformer® Products.



16-14-CON printed 4CP

CONFORMER® CAPACITY TUCK TAB

16-14-CON

10½" x 12¾" with 1" capacity (shown)

16-13-CON

9¾" x 12¼" with ¾" capacity

16-44-CON

legal size

10¼" x 15" with ¾" capacity

Price: base price **plus** upcharge
on page 30

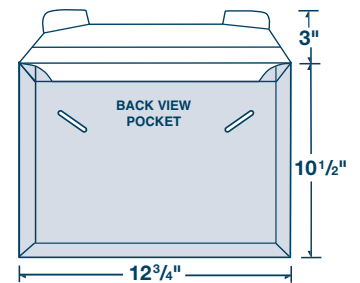

Conformer® is a registered trademark of Conformer® Products. A patent number will be added to Conformer® Products.

DISC COVERS & MAILERS

Custom printed disc covers are a *MORE* practical way to ensure consumers retain important media.

Product Specifications

- Four color process
- 12 PT or 14 PT C1S Semi-Gloss White stock is included in base price
- For added durability, 16 PT Semi-gloss White stock is available – see price table
- FREE overall GLOSS, SATIN or MATTE aqueous coating on print orders
- Holds a 5" CD/DVD
- Spot coating may be necessary if using inkjet on mailers – let us know your mailing requirements prior to production

Production Schedule

- Disc Covers: 7 - 10 production days
- Disc Mailers: 10 - 15 production days



26-12 printed 4CP

DISC MAILER 26-12

Price: base price **plus** upcharge shown below

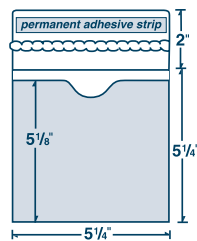

DISC COVER with OPTIONAL CLOSURE NOTCH ♥ 26-03

Closure notch is optional – specify when ordering

Price: shown below

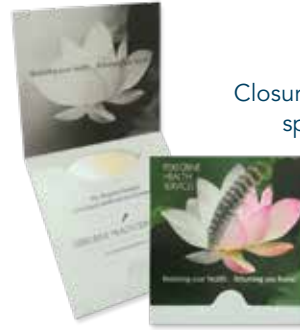
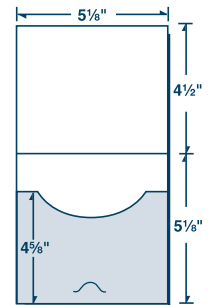

< 26-03 printed 4/1



26-48 printed 4CP

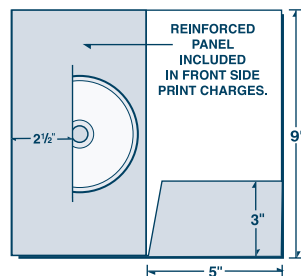

DISC COVER with POCKET 26-48

Price: base price **plus** upcharge shown below

26-19 > printed 4CP (4/4)



DISC MAILER 26-19

Folds up & seals to protect disc – includes a pocket for documents

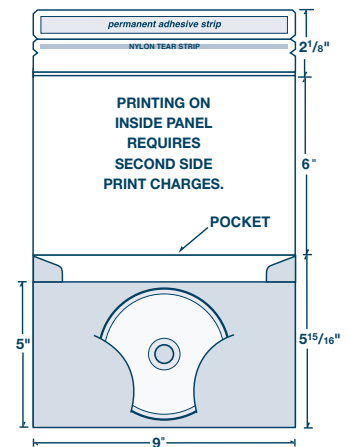

Price: base price **plus** upcharge shown below

DISC COVERS & MAILERS - BASE PRICE	250	500	1000	1500	2000	2500	3000	5000	7500	10000
Four Color Process	5.352	2.988	1.612	1.202	0.948	0.793	0.690	0.503	0.485	0.450
OPTIONS: ADD TO BASE										
Four Color Process (2nd side)	1.706	0.871	0.513	0.387	0.319	0.274	0.251	0.195	0.169	0.166
12 PT C2S Semi-gloss White Stock	0.058	0.041	0.036	0.034	0.033	0.033	0.032	0.031	0.030	0.030
14 PT C2S or 16 PT C1S Semi-gloss White Stock	0.104	0.077	0.068	0.064	0.062	0.060	0.058	0.057	0.055	0.055
16 PT C2S Semi-gloss White Stock	0.165	0.119	0.105	0.098	0.095	0.092	0.089	0.087	0.084	0.082
Upcharge: 26-12, 26-48	0.440	0.330	0.294	0.294	0.294	0.294	0.294	0.294	0.294	0.294
Upcharge: 26-19	0.697	0.589	0.551	0.551	0.551	0.551	0.551	0.551	0.551	0.551
Aqueous Coating - Flood Gloss, Satin or Matte (on print orders)	FREE	FREE	FREE	FREE	FREE	FREE	FREE	FREE	FREE	FREE
Aqueous Coating - Spot	0.642	0.350	0.212	0.145	0.127	0.113	0.100	0.065	0.059	0.054

(R) Price shown is per piece

INDEX TABS

Add MORE organization to your portfolio or binder!
Add custom tabs – printed & cut to your specifications!



Mylar coating on the tabs prevents wear and makes for easy flipping.

✓ Need a bit MORE than the basics? Call for custom options.
Four color process, custom tab cuts, foil stamping and MORE!



< Custom Diecut
5 Tab Set printed 4CP



6 Tab Set printed 4CP

Included

- Sheet sizes: 11" x 8½", 8½" x 5½"
- Typesetting and printing on the FRONT and BACK of the tab (only) in black ink
- 90 lb. white index
- Clear or colored mylar tabs
- Binding edge is clear mylar reinforced
- 5/16" diameter round holes
- ½" tab extension
- Packaged uncollated

Additional Options – see table below

- PMS ink colors or solid reverse printing on tabs
- 110 lb. white index
- ¼", 3/8", 5/8" tab extensions
- Collate

Production Schedule

- 90 lb. or 110 lb. white index: 10 production days.
- Other options: varies based on the specifics of your order

Mylar Tab Colors (Clear mylar is also available. Colors shown are printed process representations.)

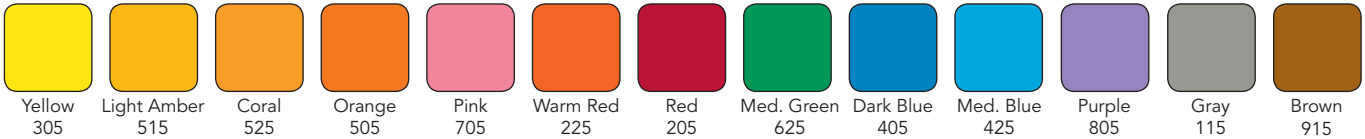

INDEX TAB PRICES (PER SET)	50	100	150	250	500	1000	1500	2000	2500	3000	5000
1 TAB/SET (11" x 8½" or 8½" x 5½")	8.430	4.215	2.810	1.687	0.843	0.422	0.352	0.315	0.292	0.282	0.203
2 TABS/SET (11" x 8½" or 8½" x 5½")	8.430	4.215	2.810	1.687	0.843	0.510	0.485	0.433	0.413	0.400	0.308
3 TABS/SET (11" x 8½" or 8½" x 5½")	8.430	4.215	2.810	1.687	0.843	0.658	0.622	0.555	0.532	0.522	0.443
4 TABS/SET (11" x 8½" or 8½" x 5½")	8.430	4.215	2.810	1.687	0.843	0.802	0.753	0.675	0.652	0.640	0.555
5 TABS/SET (11" x 8½" or 8½" x 5½")	8.430	4.215	2.810	1.687	0.953	0.948	0.887	0.795	0.772	0.760	0.667
6 TABS/SET (11" x 8½" or 8½" x 5½")	8.430	4.215	2.810	1.687	1.097	1.095	1.020	0.915	0.892	0.880	0.780
7 TABS/SET (11" x 8½" or 8½" x 5½")	8.430	4.215	2.810	1.687	1.280	1.238	1.153	1.033	1.012	1.000	0.892
8 TABS/SET (11" x 8½" or 8½" x 5½")	8.430	4.215	2.810	1.760	1.425	1.385	1.285	1.155	1.132	1.122	1.038
9 TABS/SET (11" x 8½" or 8½" x 5½")	8.430	4.215	2.810	1.935	1.577	1.530	1.418	1.275	1.253	1.240	1.155
10 TABS/SET (11" x 8½" or 8½" x 5½")	8.430	4.215	2.810	2.162	1.722	1.675	1.552	1.395	1.372	1.362	1.270
11 TABS/SET (11" x 8½" or 8½" x 5½")	8.430	4.215	3.090	2.390	1.873	1.822	1.685	1.517	1.493	1.480	1.388
12 TABS/SET (11" x 8½" or 8½" x 5½")	8.430	4.215	3.358	2.565	2.015	1.967	1.818	1.635	1.612	1.602	1.555
13 TABS/SET (11" x 8½" or 8½" x 5½")	8.430	4.215	3.592	2.757	2.165	2.112	1.952	1.757	1.733	1.720	1.677
14 TABS/SET (11" x 8½" or 8½" x 5½")	8.430	4.692	3.837	2.940	2.313	2.258	2.083	1.938	1.915	1.902	1.795
15 TABS/SET (11" x 8½" or 8½" x 5½")	8.430	4.948	4.080	3.130	2.462	2.402	2.217	2.128	2.103	2.092	1.917

(R) Price shown is per set

OPTIONS: ADD TO TAB/SET PRICE

110 lb. white index	Add \$15.00 per 1000 tabs
PMS colored ink	Add \$125.00 per order, per color
Solid reverse tab printing	Add \$67.00 per order, per color
Tab extensions - ¼", 3/8", 5/8"	Add \$67.00 set-up
Collating	Add \$25.00 per 1000 tabs (\$50.00 minimum)

(R)

Please call for pricing on legal size tabs, colored or ivory index, 30% recycled index, body printing, write-on & toner receptive tabs.

BINDERS

The full package! A printed binder & coordinating materials.
Paper is lighter weight – saves on shipping.

Laminated Binder Specifications

- Four color process
- 20 PT C1S Semi-gloss White stock
- Gloss lamination is included – additional charge for Matte or Soft-Touch lamination (see price table below)

Aqueous Coated Binder Specifications

- Four color process
- 24 PT C1S Semi-gloss White stock
- FREE overall aqueous coating
 - choose GLOSS, SATIN or MATTE
- Additional charge for Soft-Touch coating
- Additional charge for lamination
 - gloss, matte or Soft-Touch
- A variety of card slots, brochure slits & other pocket options are available FREE
 - see page 22 or refer to design templates
- Binder size varies with ring capacity – see design template

Production Schedule

- 10 production days
- Soft-Touch aqueous coating: add 1 production day
- Item 88-07 production time varies, based on quantity



Capacities:
1/2", 3/4", 1"



See page 33 for optional Index Tabs

88-71 printed 4CP



88-01 printed 2PMS

✓ When you need MORE than "paper" consider vinyl or poly.
Turned edge and short-run digital binders also available! Call.

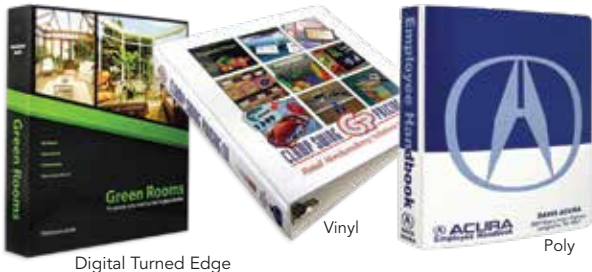

Digital Turned Edge

Vinyl

Poly

POCKET BINDER

♥ 88-01

Two pockets (shown)

88-04

One right pocket only

Price: shown below

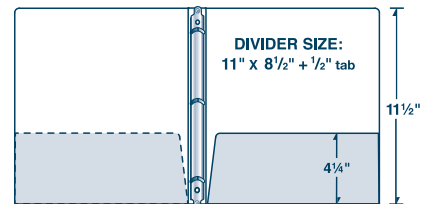

BINDERS - BASE PRICE (20 PT gloss laminated or 24 PT aqueous coated - 1/2" rings)	250	500	1000	1500	2000	2500	3000	5000	7500	10000
Four Color Process	6.424	4.361	3.480	3.227	3.085	2.961	2.897	2.745	2.527	2.281
OPTIONS: ADD TO BASE										
Additional PMS Color/Heavy Ink Coverage (per side)	0.642	0.350	0.212	0.145	0.127	0.113	0.100	0.065	0.059	0.054
Upcharge: 88-71	0.336	0.198	0.184	0.180	0.171	0.153	0.133	0.085	0.062	0.047
Upcharge: 88-07	1.310	0.823	0.805	0.798	0.767	0.767	0.767	0.749	0.749	0.749
Lamination - Matte on 20 PT	0.216	0.216	0.160	0.160	0.157	0.149	0.146	0.141	0.139	0.134
Lamination - Soft-Touch on 20 PT	0.325	0.310	0.250	0.243	0.239	0.228	0.221	0.210	0.207	0.203
Lamination - Gloss on 24 PT	0.629	0.407	0.335	0.296	0.279	0.276	0.274	0.267	0.262	0.262
Lamination - Matte on 24 PT	0.789	0.624	0.493	0.456	0.436	0.425	0.420	0.408	0.401	0.395
Lamination - Soft Touch on 24 PT	0.954	0.717	0.585	0.539	0.518	0.504	0.495	0.477	0.468	0.465
Aqueous Coating (Flood Gloss, Satin or Matte) on 24 PT	FREE	FREE	FREE	FREE	FREE	FREE	FREE	FREE	FREE	FREE
Aqueous Coating - Flood Soft-Touch on 24 PT	1.171	0.654	0.379	0.275	0.223	0.204	0.186	0.127	0.117	0.106
3/4" Metal Ring Mechanism	0.133	0.133	0.133	0.133	0.133	0.133	0.133	0.133	0.133	0.133
1" Metal Ring Mechanism	0.258	0.258	0.258	0.258	0.258	0.258	0.258	0.258	0.258	0.258

(R) Price shown is per piece

BINDERS



88-71 printed 4CP

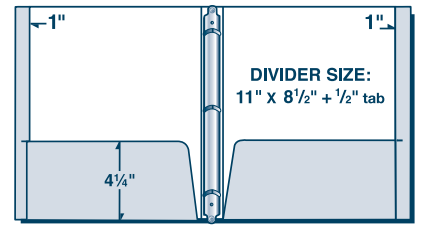

POCKET BINDER with REINFORCED EDGES

♥ 88-71

Two pockets

Price: base price **plus** upcharge on page 34



88-07 printed 2PMS plus heavy coverage

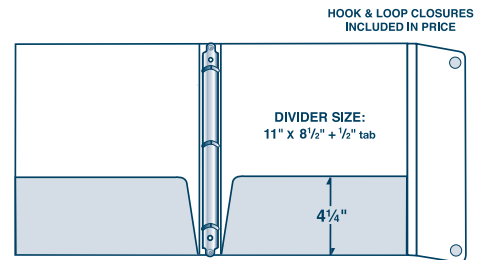

POCKET BINDER with PORTFOLIO FLAP

88-07

Two pockets with wrap around flap – specify white or black hook-and-loop closures

Price: base price **plus** upcharge on page 34



26 PT Eco Kraft 100% ♻️ printed 2PMS

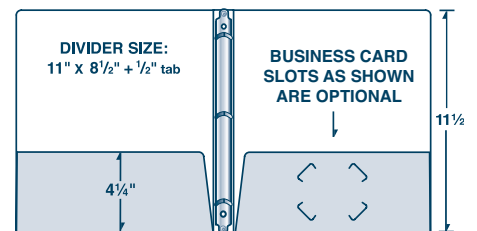

♻️ 100% RECYCLED ECO BINDER 88-01-ECO

Manufactured on 26 PT Eco Kraft stock One or two PMS ink colors or foil stamp

Price: shown below

♻️ 100% RECYCLED ECO BINDER PRICES (26 PT Eco Kraft stock with 1/2" metal rings)	250	500	1000	1500	2000	2500	3000	5000
Print One PMS Color - No Heavy Coverage	5.994	3.976	3.211	2.985	2.905	2.826	2.792	2.673
Print Two PMS Colors - No Heavy Coverage	6.635	4.326	3.423	3.130	3.032	2.939	2.892	2.738
Foil Stamp - One Area up to 15 sq. in.	6.727	4.560	3.580	3.291	3.203	3.113	3.073	2.918
OPTIONS: ADD TO BASE								
3/4" Metal Ring Mechanism	0.133	0.133	0.133	0.133	0.133	0.133	0.133	0.133
1" Metal Ring Mechanism	0.258	0.258	0.258	0.258	0.258	0.258	0.258	0.258

(R) Price shown is per piece

DOCUMENT FOLDERS - Design Your Own

Feeling creative? Design your own! Select a style from page 37 and provide us with your art.

Product Specifications

- Available printed, foil stamped or embossed
- Print price includes **one standard ink color** (no heavy coverage), in any location on the flap, face or pocket (one side of the sheet). Copy must remain 3/8" in from all edges. **Refer to the color chart on inside flap of the back cover.**
- On most items, second side printing (inside of flap) is available for the additional charge below. Add the cost of each standard ink color used on the second side.
- Non-standard PMS ink colors are available for the additional charge below.
- Choose any standard stock selection for Document Folders **from the color chart on inside flap of the back cover. Call for other stocks.**
- Business card slots are available on limited items as shown - see additional charge in table below. Holds a standard 3 1/2" x 2" business card.

Available in the **POCKET** or **FLAP** of 01-01, 02-01 & 02-11:

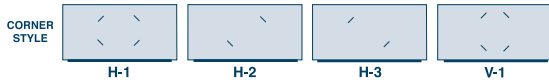

Available in the **POCKET** of 01-01, 02-01 & 02-11:

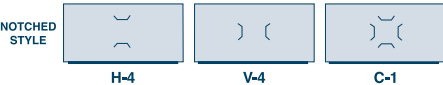

Production Schedule

- 10 production days



DOCUMENT FOLDERS - DESIGN YOUR OWN	150	250	500	1000	1500	2000	2500	3000	5000	7500	10000
ONE Standard Ink Color											
01-01	1.405	1.008	0.693	0.457	0.434	0.420	0.400	0.374	0.343	0.320	0.312
02-01	1.630	1.244	0.828	0.596	0.524	0.488	0.464	0.443	0.409	0.386	0.373
02-11	2.232	1.744	1.175	0.843	0.770	0.734	0.704	0.680	0.642	0.614	0.598
19-02, 19-03, 19-04, 19-05	N/A	N/A	N/A	0.690	0.619	0.581	0.554	0.525	0.480	0.453	0.438
ONE Standard Foil or Emboss - One Area Up to 36 Sq. In.											
01-01	N/A	1.291	0.746	0.598	0.532	0.498	0.478	0.463	0.436	0.421	0.412
02-01	N/A	1.358	0.843	0.643	0.577	0.546	0.527	0.511	0.484	0.468	0.459
02-11	N/A	1.463	0.945	0.745	0.677	0.643	0.624	0.607	0.581	0.564	0.555
OPTIONS: ADD TO PRINT BASE PRICE											
Additional Standard Ink Color (1st Side)	0.275	0.172	0.100	0.070	0.053	0.047	0.047	0.042	0.033	0.032	0.032
Standard Ink Color (2nd side - per color)	0.275	0.172	0.100	0.070	0.053	0.047	0.047	0.042	0.033	0.032	0.032
Non-Standard PMS Ink Color	Add \$80 (R) for each Non-Standard PMS ink color										
Business Card Slots (print, foil or emboss order)	0.500	0.300	0.150	0.075	0.075	0.075	0.075	0.075	0.075	0.075	0.075

(R) Price shown is per piece

DOCUMENT FOLDERS - Design Your Own



< 01-01 printed 1PMS

01-01 printed 2PMS >

10¼" x 4½"
DOCUMENT FOLDER

♥ 01-01

Additional charge for card slots

Price: see page 36

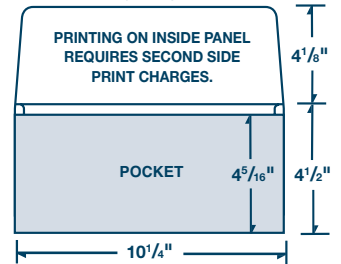

< 02-01 printed 2PMS

02-01 printed 1PMS >

9 7/8" x 6"
DOCUMENT FOLDER

♥ 02-01

Additional charge for card slots

Price: see page 36

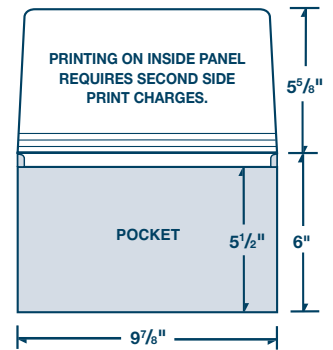

^ 02-11 printed 1PMS

02-11 printed 2PMS >

9 7/8" x 6"
EXPANSION DOCUMENT FOLDER

♥ 02-11

Expands to hold up to 7/8"
Ships flat with expansion gusset out

Additional charge for card slots

Price: see page 36

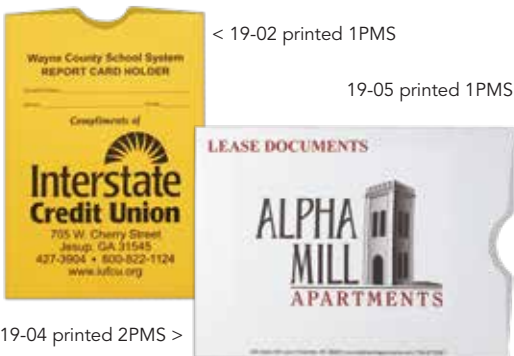
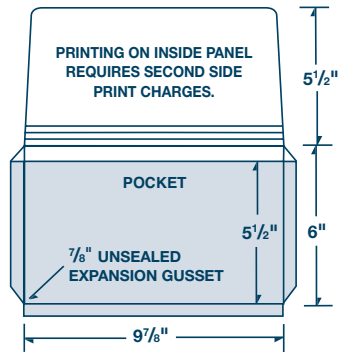

< 19-02 printed 1PMS

19-05 printed 1PMS >

19-04 printed 2PMS >



19-03 printed 1PMS >

PULL-OUT SLEEVES

19-02

5" x 7¼"

19-03

5¾" x 8¾"

19-04

6¼" x 9"

19-05

4½" x 9"

Price: see page 36

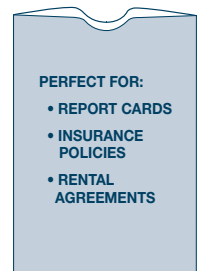

- PERFECT FOR:**
- REPORT CARDS
 - INSURANCE POLICIES
 - RENTAL AGREEMENTS

DOCUMENT FOLDERS - Standard Designs

These standard designs make it easy!
Ready to personalize - just add your imprint & logo.

Product Specifications

- Except where noted, designs include imprinting in one standard ink color on one standard stock **from the color chart on inside flap of the back cover.**
- Add your logos and imprint information to the template for the design you are ordering. Or we can set-up the imprint for you (standard tpestyles will be used unless other specific instructions are given). Templates and art submission guidelines at foldersolutions.com. Any changes to standard design copy will be priced as custom – see page 36.

Production Schedule

- Without card slots: 7 production days
- With card slots: 10 production days

Business Card Slots

Available on limited items as shown – see additional charge below. Holds a standard 3½" x 2" business card.

Available in the **POCKET** or **FLAP** of 01-01, 02-01 & 02-11:



Available in the **POCKET** of 01-01, 02-01 & 02-11:

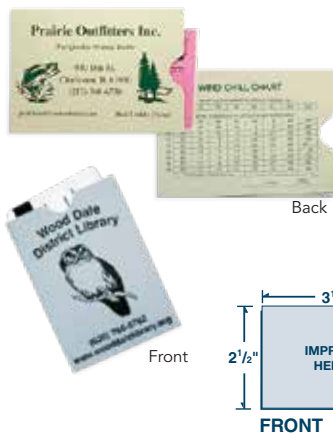
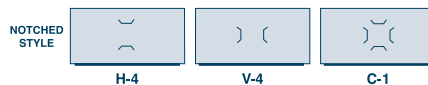

LICENSE OR CARD SLEEVE
♥ 19-01
3½" x 2½"

One standard ink color
on one standard stock

Holds a 3¾" x 2⅛" card

Price: see below

FREE Optional Back Cover Forms for Item 19-01 (choose one).

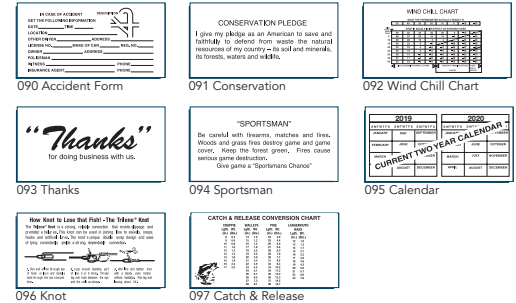

TRAVEL DOCUMENTS
♥ 01-01-055
10¼" x 4½"

One standard ink color
on one standard stock

Price: see below



TRAVEL DOCUMENTS
01-01-002
10¼" x 4½"

Standard red & blue ink on
marble crush white stock

Price: see below

STANDARD DESIGN DOCUMENT FOLDER PRICES	150	250	500	1000	1500	2000	2500	3000	5000	7500	10000
19-01-XXX (on page 38)	1.012	0.700	0.432	0.258	0.255	0.231	0.227	0.218	0.196	0.182	0.175
01-01-XXX (on pages 38-40)	1.071	0.808	0.593	0.407	0.400	0.395	0.380	0.357	0.333	0.314	0.307
04-01-001 (on page 39)	1.766	1.295	0.845	0.627	0.571	0.519	0.493	0.472	0.445	0.428	0.417
02-01-XXX (on pages 40)	1.297	1.044	0.728	0.546	0.491	0.463	0.444	0.426	0.399	0.380	0.368
02-11-XXX (on page 40)	1.899	1.544	1.075	0.793	0.737	0.709	0.684	0.663	0.632	0.607	0.593
OPTIONS: ADD TO FOLDER PRICE											
Business Card Slots	0.500	0.300	0.150	0.075	0.075	0.075	0.075	0.075	0.075	0.075	0.075

(R) Price shown is per piece

See Document Folder Stock selections & Ink Colors on inside flap of the back cover.

DOCUMENT FOLDERS - Standard Designs



INCOME TAX
 ♥ 01-01-009
 4½" x 10¼"

One standard ink color
 on one standard stock

Price: see page 38

Face Only



BOWLING PAYMENT RECORD
 ♥ 01-01-019
 4½" x 10¼"

Standard red & blue ink on
 marble crush white stock

Price: see page 38



Face Only

CEMETERY DEED
 ♥ 01-01-016

10¼" x 4½"
 One standard ink color
 on one standard stock

Price: see page 38



Face Only

FUNERAL LILY
 01-01-308
 4½" x 10¼"

One standard ink color
 on one standard stock

Price: see page 38



Face Only

VALUABLE PAPERS
 01-01-025
 4½" x 10¼"

One standard ink color
 on one standard stock

Price: see page 38

LEGAL DOCUMENTS
 ♥ 01-01-015
 10¼" x 4½"

One standard ink color
 on one standard stock

Price: see page 38



Face Only

LEGAL DOCUMENTS
 01-01-101
 10¼" x 4½"

One standard ink color
 on one standard stock

Price: see page 38



Face Only

CREDIT UNION
 01-01-022
 4½" x 10¼"

One standard ink color
 on one standard stock

Price: see page 38



Pocket

Face

Flap



Face

Pocket

INSURANCE PAPERS
 01-01-018
 10¼" x 4½"

One standard ink color
 on one standard stock

Price: see page 38



Face

Inside Pockets

**BANK DEPOSIT &
 WITHDRAWAL RECORD**
 04-01-001
 3¾" x 7"

One standard ink color
 on one standard stock

Price: see page 38

NEW DIGITAL BOOKLETS

Feature *MORE* in one promotional tool.
NEW Digital Booklets are a real page turner!



Product Specifications

- Four color process digital print only
- Choose from 80 lb. gloss or matte text
- Standard size is 8½" x 11"
- Self cover
- 8 - 40 page count. Page counts must be in multiples of four.
- Saddle stitched (stapled) at center score.

Production Schedule

- 7 - 10 production days

✓ Need to add a booklet to your folder or cover?
 See page 23 for Stitched Inserts.



NEW DIGITAL BOOKLET D-13-XX (page count)

Price: shown below

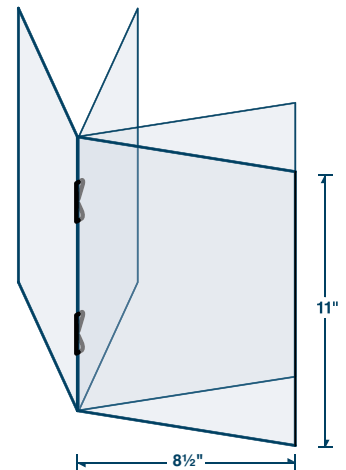

SELF-COVER STITCHED BOOKLETS - 8.5" x 11" Size	50	100	150	200	250	300	350	400	450	500	750	1000
8-Page - 80 lb. Gloss or Matte Text	2.872	1.652	1.430	1.290	1.160	1.108	1.062	1.022	1.000	0.977	0.928	0.918
12-Page - 80 lb. Gloss or Matte Text	3.687	2.277	2.020	1.847	1.630	1.608	1.548	1.493	1.468	1.435	1.373	1.363
16-Page - 80 lb. Gloss or Matte Text	4.255	2.735	0.261	2.402	1.893	1.875	1.860	1.850	1.843	1.837	1.817	N/A
20-Page - 80 lb. Gloss or Matte Text	5.062	3.135	2.640	2.367	2.192	2.175	2.162	2.152	2.145	2.138	N/A	N/A
24-Page - 80 lb. Gloss or Matte Text	5.667	3.563	3.217	2.935	2.608	2.592	2.578	2.568	2.562	2.555	N/A	N/A
28-Page - 80 lb. Gloss or Matte Text	6.330	4.100	3.717	3.398	3.027	3.008	2.995	2.987	2.978	2.973	N/A	N/A
32-Page - 80 lb. Gloss or Matte Text	7.095	4.683	4.217	3.863	3.443	3.425	N/A	N/A	N/A	N/A	N/A	N/A
36-Page - 80 lb. Gloss or Matte Text	7.717	5.227	4.718	4.327	3.860	3.842	N/A	N/A	N/A	N/A	N/A	N/A
40-Page - 80 lb. Gloss or Matte Text	8.467	5.710	5.218	4.792	4.277	N/A	N/A	N/A	N/A	N/A	N/A	N/A

(R) Price shown is per booklet

Please call for pricing on other options not listed.

DIGITAL PRINT FOLDERS

You can have **FULL** color and a **LOW** minimum quantity with these Digital Print folders. It's a great fit!

Product Specifications

- Four color process digital print only
- No heavy coverage or large solid blocks of ink
- Logos, line copy and photos cannot exceed 50% coverage of the surface area
- Avoid registering artwork to scores - we recommend fading dark areas away from scores (like photo at right)
- Digital printing will not match other offset printed pieces
- Choose from 100 lb. Gloss Coated Cover or uncoated 80 lb. Smooth White
- FREE business card slots are available – holds a standard 3½" x 2" business card (refer to item design templates)

Production Schedule

- 7 production days



D-01-01

Digital Print Stock Selections



5¾" x 8¾" with TWO POCKETS D-68-02

Four color process on front & back cover, plus pockets

OPTIONAL: Free card slots (as shown) are available in the pocket(s) – specify when ordering

Price: shown below

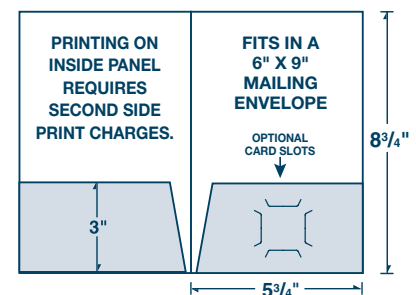

4½" x 10¼" DOCUMENT FOLDER D-01-01

Four color process on flap, face & pocket

OPTIONAL: FREE card slots (as shown) are available centered in the flap or pocket – specify when ordering

Price: shown below

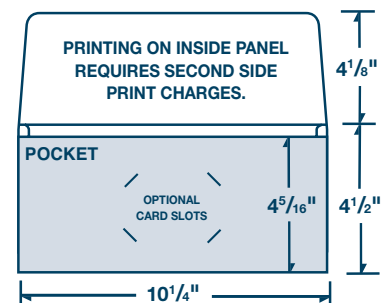

DIGITAL PRINT FOLDER PRICES Includes your choice of the stocks listed above.											
Four Color Process Digital Print Base	50	100	150	200	250	300	500	750	1000	1500	2000
D-01-01	3.499	2.228	1.756	1.574	1.422	1.339	1.093	1.030	0.970	0.916	0.861
D-06-04	3.344	2.074	1.602	1.420	1.267	1.183	0.939	0.877	0.818	0.762	0.709
D-02-01, D-02-12	4.213	2.688	2.109	1.892	1.705	1.604	1.316	1.238	1.115	1.007	0.905
D-48-01	5.356	3.536	2.948	2.520	2.193	1.945	1.397	1.156	1.051	N/A	N/A
D-68-02	5.356	3.536	2.948	2.608	2.334	2.152	1.750	1.389	1.226	N/A	N/A
D-19-01	N/A	N/A	N/A	1.229	1.025	0.884	0.604	0.469	0.405	0.304	0.279
OPTIONS: ADD TO DIGITAL PRINT FOLDER BASE											
D-01-01, D-02-01 (2nd side)	0.393	0.318	0.307	0.300	0.290	0.283	0.273	0.270	0.264	0.264	0.264
D-48-01 (2nd side)	0.714	0.530	0.472	0.443	0.424	0.412	0.390	0.374	0.367	N/A	N/A
D-68-02 (2nd side)	1.071	0.884	0.826	0.797	0.778	0.766	0.743	0.724	0.717	N/A	N/A
Business Card Slots (refer to design templates)	FREE	FREE	FREE	FREE	FREE	FREE	FREE	FREE	FREE	FREE	FREE

(R) Price shown is per piece

DIGITAL PRINT FOLDERS



6" x 9 7/8" DOCUMENT FOLDER D-02-01

Four color process on flap, face & pocket

OPTIONAL: Free card slots (as shown) are available centered in the flap or pocket – specify when ordering

Price: see page 42

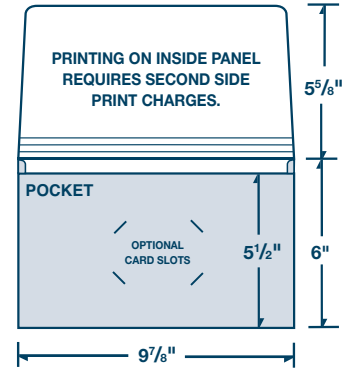

6" x 9 5/8" EXPANSION FOLDER NEW D-02-12

Expands to hold up to 3/4" ships flat with expansion gusset out
Four color process on flap, face & pocket

OPTIONAL: Free card slots (as shown) are available centered in the flap or pocket – specify when ordering

Price: see page 42

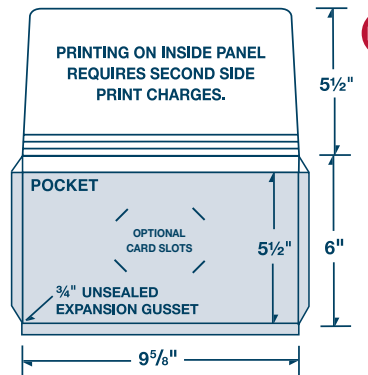

4" x 9 1/4" RECEIPT HOLDER D-06-04

Four color process on front of pocket & back panel

OPTIONAL: Free card slots (as shown) are available in the pocket – request when ordering

Price: see page 42

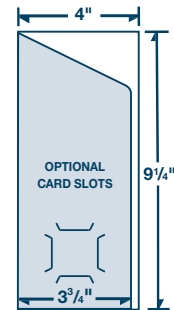

4" x 9" with TWO POCKETS D-48-01

Four color process on front & back cover, plus pockets

OPTIONAL: Free card slots (as shown) are available in the pocket(s) – specify when ordering

Price: see page 42

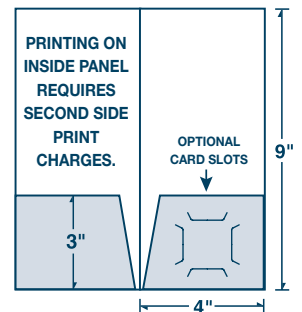

3 1/2" x 2 1/2" CARD SLEEVE ♥ D-19-01

Four color process on front & back

Holds a 3 3/8" x 2 1/8" card – (CR80 credit card size)

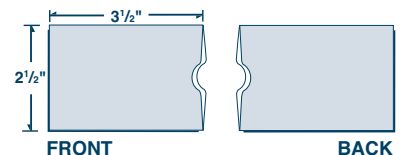

✓ 100# Gloss Cover is not available on this item

BUSINESS TOOLS



Choose ColorWorx® for fast, economical, four color process printing. Here's a sampling of our best-selling customer favorites.

- All ColorWorx® products are printed in 4CP
- Products are gang run offset printed
- Digitally printed products where indicated

Production Schedule

- 5 working days or less

Gang Run Products - Color Matching

ColorWorx® products are four color process only, printed in "gang run" style. Your job will be run on a press sheet with other jobs, and printed to standard ink color densities. The overall dominant color on a sheet may cause individual job colors to shift slightly. **ColorWorx® does not guarantee an exact color match.** Reorders may vary between runs. If you require a color match or your job needs to match other pieces, let us know prior to placing your order. Gang run products are only sold in quantities divisible by 500.

Proofs

Proofs on ColorWorx® products are available for an additional charge.



COLORWORX® PRICING											
PRICES (4/0, 4/1, 4/4)	STOCK	ITEM	250	500	1000	1500	2000	2500	3000	5000	
Business Cards	14 PT C2S UV Coated	50-71-001	N/A	0.066	0.042	0.034	0.029	0.027	0.025	0.024	
Business Cards	100 lb. Smooth Uncoated	50-D-71-001-SM	0.109	0.073	0.046	0.039	0.036	0.034	0.033	0.030	
Postcards 4" x 6"	14 PT C2S UV Coated	50-21-001	N/A	0.186	0.111	0.094	0.084	0.077	0.072	0.057	
Postcards 5.5" x 8.5"	14 PT C2S UV Coated	50-21-002	N/A	0.391	0.231	0.196	0.175	0.160	0.151	0.114	
Postcards 6" x 9"	14 PT C2S UV Coated	50-21-003	N/A	0.391	0.231	0.196	0.175	0.160	0.151	0.114	
Postcards 6" x 11"	14 PT C2S UV Coated	50-21-004	N/A	0.478	0.270	0.229	0.204	0.187	0.184	0.146	
Tri-Fold Brochure 8.5" x 11"	80 lb. Gloss or Matte Text	50-11-006-TRI	N/A	0.406	0.237	0.187	0.165	0.151	0.138	0.118	
Tri-Fold Brochure 8.5" x 11"	100 lb. C2S Gloss Cover	50-D-11-006-TRI-100C	0.852	0.593	0.377	0.336	0.304	0.297	N/A	N/A	
Flat Sell Sheet 8.5" x 11"	80 lb. Gloss or Matte Text	50-11-001	N/A	0.380	0.212	0.162	0.139	0.126	0.113	0.094	
Flat Sell Card 8.5" x 11"	14 PT C2S UV Coated	50-11-001-14C	N/A	0.550	0.324	0.275	0.246	0.225	0.212	0.160	
Flat Rack Card 4" x 9"	14 PT C2S UV Coated	50-21-020	N/A	0.312	0.194	0.170	0.149	0.134	0.128	0.126	
Door Hanger 4" x 9"	14 PT C2S UV Coated	50-D-18-003	0.677	0.370	0.233	0.207	0.182	0.171	0.169	0.168	
Door Hanger 4.25" x 11"	14 PT C2S UV Coated	50-D-18-004	0.677	0.428	0.267	0.220	0.191	0.175	0.169	0.168	
Door Hanger 4" x 9" with Perf-off Card	14 PT C2S UV Coated	50-D-18-005	0.677	0.407	0.263	0.214	0.187	0.175	0.169	0.168	
Door Hanger 4.25" x 11" with Bus Card Slits	14 PT C2S UV Coated	50-D-18-007	0.745	0.509	0.293	0.246	0.207	0.190	0.187	0.166	

(R) Price shown is per piece

BUSINESS CARDS
50-71-001 (UV Coated)

3.5" x 2" • 14 PT C2S White Cover • UV coat front side • Write on back

50-D-71-001-SM (Uncoated)

3.5" x 2" • 100 lb. uncoated Smooth White • Digital Print

Price: see page 44



✓ Every folder needs a business card!

POSTCARDS

14 PT C2S White Cover • UV coat front side • Inkjet on back

50-21-001 4" x 6"
50-21-002 5.5" x 8.5"
50-21-003 6" x 9"
50-21-004 6" x 11"

Price: see page 44



✓ Announce events, campaigns, new products & more!

TRI-FOLD BROCHURES
50-11-006-TRI

 tri-folded to 3.6875" x 8.5"
 8.5" x 11" • 80 lb. gloss or 80 lb. matte text

50-D-11-006-TRI-100C

 tri-folded to 3.6875" x 8.5"
 8.5" x 11" • 100 lb. C2S Gloss Cover • Digital Print

Price: see page 44



✓ Fits our 4 3/8" folder brochure slit!

FLAT SELL SHEETS • RACK & SELL CARDS
50-11-001 Flat Sell Sheet

8.5" x 11" • 80 lb. gloss or 80 lb. matte text • Matte is easy to write on!

50-11-001-14C Flat Sell Card

8.5" x 11" • 14 PT C2S White Cover • UV coat front side • Write on back

50-21-020 Flat Rack Card

4" x 9" • 14 PT C2S White Cover • UV coat front side • Write on back

Price: see page 44

DOOR HANGERS

14 PT C2S White Cover • UV coat front side • Write on back

50-D-18-003 4" x 9"
50-D-18-004 4.25" x 11"
50-D-18-005 4" x 9" with 4" x 2" perf-off card at bottom
50-D-18-007 4.25" x 11" with business card slits at bottom

Price: see page 44

✓ Businesses love to promote within neighborhoods!



See the full ColorWorx® catalog for MORE! Including plastic cards, gift card holders, note cards & posters!

COMPLETE CUSTOMIZATION

Stand apart from the ordinary...with our diverse line of custom folders and MORE packaging options.

Custom Die Cutting

Let your imagination run wild and we'll bend cutting and scoring rule around it! It's easy to add that "WOW" factor by die cutting around parts of your artwork design on the front cover or pockets.

Custom Design Templates

Did you know we can provide a template for custom items? When you're ready to begin the design phase of a custom project, let us know. We'll help you make sure all the critical details will work and fit to the scores.



Custom Die Cut

Custom Die Cut



Sculptured Emboss + Foil

Custom Die Cut + Emboss

Multi-Level Embossing

Add dimension to your company logo with custom embossing. Use a sculptured effect to bring out realism in your image. How about adding a beveled edge to your type for some added emphasis? From single level raised emboss to chiseled deboss, we can handle all requests.

Coating Effects

Why choose the same flood gloss aqueous coating every time? Consider dressing up your next project with Soft-Touch coating, spot UV, spot lamination, strike-thru's and MORE.



Spot UV Coating + Emboss

Special Stocks

Custom stocks are available on request or choose from our complete line of standard paper stocks.

Extra Features

Add business card slots, brochure slits, disc slits & hubs, inserts, stitched brochures or tab dividers to almost any folder, binder or packaging item.



Custom Die Cut + Multiple Foils registered to Sculptured Emboss

IMPORTANT INFORMATION

ARTWORK

Guidelines & Templates - We have an all digital workflow and work with all Mac and Mac compatible files. Create artwork using accepted programs: current versions of InDesign, Illustrator and PhotoShop. *We cannot accept files created with: Microsoft Word, Publisher and PowerPoint.* Artwork for catalog and custom items **MUST** be created on our FREE item templates. If supplying artwork as a .PDF, follow all art guidelines to avoid production delays. Download art guidelines & templates at foldersolutions.com. Send all file elements being used – including printer & screen fonts and embedded graphics. When sending digital files via our web upload or email, **all files MUST include your dealer information, purchase order number and job name.** Incorrect files and files created without our item template may delay production and can incur prep charges. Charges for corrections, alterations and set-up will be billed at \$180.00 (P) per hr.

Copy Errors - All submitted copy is reviewed before production. We pride ourselves on making every effort to ensure accuracy and that your expectations are met. **However, we are not liable for errors in customer submitted files.**

ARTWORK / DIE STORAGE

To assist our customers with reorders, we store all archived art files and dies (die cutting, foil, emboss, etc.) for **24 months**. At that point, if we have not received a written request for return, materials are recycled without notice. NOTE: When working with a graphic designer, always ask them to provide you with a final file copy of your artwork.

CHANGES / CANCELLATIONS

Changes to orders in progress may require additional cost and/or time. Cancellation after work has begun requires payment for work performed (preflight, materials ordered or generated and re-stocking fees). A minimum cancellation fee of \$50.00 (P) is applied once an order is entered into our system.

COATINGS

Aqueous - Water-based coating that seals the ink against smearing. Adds no durability to the product. If necessary, an overall aqueous coating (gloss, satin or matte) is applied FREE on print orders. **If a coating finish is not specified, gloss will be used.** Matte coating can alter the appearance of print color. ♻️ Our aqueous coatings are recyclable.

Aqueous Soft-Touch - A special effect matte aqueous coating that gives the product a soft or suede-like feel. Adds no durability to the product. It needs to be applied to a coated sheet and requires an additional 24 hrs. production dry time. When used on overall solid black (or dark PMS color), it has a tendency to show imperfections. Like any matte coating, it can alter the appearance of print color. See price tables or call for additional charge.

♻️ Soft-Touch Aqueous coating can be recycled.

Lamination - Bonds a strong, protective film of plastic to the sheet. Most durable of the available coatings. Available in gloss, matte or Soft-Touch finish. Matte or Soft-Touch lamination can alter the appearance of print color. See price tables or call for additional charges.

♻️ Plastic lamination is not recyclable.

Spot Coatings - We have a wide range of spot coating options and applications to achieve a gloss/matte combination effect. Costs vary depending on material and if coating is applied in-line or off-line. Call for information and assistance.

MAILERS: let us know your mailing requirements prior to production. A spot coating may be necessary if using inkjet.

UV Coating - A HIGH GLOSS finish that seals the ink against smearing. Adds no durability to the product. Exposure to ultra-violet light cures the finish to a brilliant shine. Needs to be applied to a coated paper, such as our Semi-gloss White. Tends to fingerprint on large solid areas of dark ink (wipes away easily). You cannot write or inkjet on UV coating. See price tables for additional charge. ♻️ Our UV coating is 50% renewable with 30% soy content and can be recycled with other mixed waste.

DAMAGED GOODS / CLAIMS

In the case of cartons lost or damaged in transit, the liability is that of the carrier and not Admore® or ColorWorx®. Please mark the shipper "received damaged". It is important to inspect all materials upon arrival. Cartons may be opened for inspection, **but do not dispose of damaged merchandise or containers.** A claim must be filed with the carrier within **10 days** after receipt of merchandise. A digital photo is helpful in filing a claim with the carrier. Please contact your dealer immediately if you have received damaged merchandise. **All other claims must be made within 30 days of delivery.**

EMBOSSING

See price tables for size of emboss area included in price. Includes one area, single level raised. Copy is raised to the maximum lift allowed by the stock and your copy design. Copy needs to be 1/8" away from all sides or edges. Please call for an estimate when combining embossing with printing. Multi-level or sculptured emboss is available.

Emboss Artwork Note - Thick, bold copy is best. Recommended minimum line thickness is 2 pt.  Increase point size/weight accordingly. Certain copy will not emboss well and is best avoided, including: serif/thick-thin type styles, screens, fine lines and copy with intricate detail. Submit one color art in the size you want to appear on folder (consider maximizing the allowable square inches found in the price table). Convert type to outlines and send vector (.EPS) art. No RGB, .JPG, .GIF or web images.

♻️ Embossing has no impact on a sheet's ability to be recycled.

FOIL STAMPING

See price tables for size of one foil area included in price. See inside back cover for standard foil colors. We can order custom and special effect foil colors. Non-metallic and pearlized foils will look different when used on dark stocks. Please call for an estimate when combining foil stamping with printing.

Foil Stamp Artwork Note - For most type styles, minimum point size is 8 pt. Increase size for serif/thick-thin type styles. To avoid loss of detail and plugging do not use ultra-light type styles, screens, thin lines and copy with intricate detail and gaps no closer than 1 pt.  Submit one color art in the size you want to appear on folder (consider maximizing the allowable square inches found in the price table). Convert type to outlines and send vector (.EPS) art. No RGB, .JPG, .GIF or web images.

♻️ Paper products selectively decorated with foil are recyclable (more information at fsea.com).

OVERRUNS OR UNDERRUNS

Due to the number of production processes involved in the manufacture of your folder, it is not possible to determine the exact quantity we will complete. Please indicate your desired quantity using one of the following methods:

Standard Trade Practice - Billed for the exact quantity shipped, not to exceed 10% over or under the quantity ordered.

No Overs - Must be indicated on order. Order could run short by more than 10%. Billed for the exact quantity shipped.

Exact Quantity - Add 10% to the price for the special handling involved. No additional handling fee is applied to digital print products or prepaid orders.

No Unders - Your order may run over by more than 10%. Billed for the exact quantity shipped.

(continued on page 48)

IMPORTANT INFORMATION

PRINTING - DIGITAL

Four Color Process Only - In general, digital printing is more cost effective on smaller quantities and has shorter turn-around times. It also gives you the opportunity to print variable text or images (additional charge). As quantities go up, offset printing is usually the better choice, because the unit cost goes down. If you're planning to print using the Pantone® Matching System, offset printing will give you the best match since it uses Pantone inks. Digital printing simulates PMS colors using four color process toner inks, so color matching is less accurate. Large solid areas and screen tints produce better on an offset press. **Digital printing will not match offset printing.**

Digital Printing Artwork Note: Graphics MUST be CMYK; not RGB or PMS.

PRINTING - OFFSET

Four Color Process - The four color process print base shown in the tables includes process printing in any location on the front and back covers, plus pockets (one side of the sheet). If necessary, an overall aqueous coating (gloss, satin or matte) is applied FREE. We print to industry standard ink densities on press. **If your project requires an exception to this, or needs to match a sample, it must be clarified and approved prior to production.** Inks will appear different on uncoated or non-white stocks.

Process Artwork Note: Process graphics MUST be in CMYK and not RGB. We are not responsible for color shifts that may occur when PMS or RGB files are converted to CMYK. Do not rely on color monitors for accurate color representation.

PMS Colors - Unless specified otherwise, the print base shown in the tables includes one or two PMS ink color(s) in any location on the front and back covers, plus pockets (one side of the sheet). No heavy coverage (up to 35% coverage allowed). If necessary, an overall aqueous coating (gloss, satin or matte) is applied FREE. Orders MUST specify a PMS number or a color match charge of \$50.00 (P) per color will be applied. We print to industry standard ink densities on press. **If your project requires an exception to this, it must be clarified and approved prior to production.** Choose ink colors that are darker than the stock you select. Inks will appear different on uncoated or non-white stocks. Please call for an estimate when combining printing with embossing or foil stamping. Additional ink color and heavy coverage charges are found in the price tables.

PMS Printing Artwork Note: Define colors as spot color and not RGB or CMYK. Submit vector (.EPS art) with all type converted to outlines or 1200 dpi .TIF file. No RGB, .JPG, .GIF or web images.

 Limited ink coverage of non-metallic inks is preferred for recycling.

Heavy Ink Coverage - Refers to the increased amounts of ink necessary for solid blocks of color or ink coverage exceeding 35% or more. We will notify you of the additional charge prior to production. An overall aqueous coating (gloss, satin or matte) is applied FREE.

 Heavy ink coverage is difficult to de-ink and is not suitable for recycling.

PRODUCTION TIME

Average production time is noted for each item. Multiple processes require the most production time. Items requiring special estimates vary in production time. Production days are Monday through Friday, excluding Holidays. **Production time does not begin until credit is approved, all correct artwork components and order information is received & reviewed. Normal production time is required after return of proof.**

Rush Schedules - Schedules can often be adjusted based on the specifics of your order. **Be sure to tell us when you need it.** We frequently ship jobs early, however, if you need us to guarantee an early ship date, extra charges may apply. Expedited methods of shipping are available for an additional charge.

PROOFS

Available upon request. Your first PDF proof is FREE. Four Color Process orders (excludes Digital Folders) have the option of receiving a FREE color digital proof instead. Allow 2-3 working days to send proof.

Changes to proofs, additional proofs and actual press proofs, incur additional charges.

Color digital proofs need to be returned prior to production.

Approval or changes need to be indicated in writing. We cannot guarantee color matching to customer supplied proofs.

Normal production time is required after proof approval.

ColorWorx® Proofs are available for an additional charge. Refer to ColorWorx® catalog for cost and specific details.

RIGHTS TO PROMOTE

The plant reserves the right to use **all** products produced by the plant in the plant's advertising, promotional literature, displays and sample programs unless instructed otherwise in writing by the dealer at the time the order is placed. In addition, the purchaser agrees to assume any liability resulting from actions or demands brought against the manufacturer for patent or copyright infringements. Logos and other imprints shown in this catalog are for illustrative purposes only. They do not imply endorsement, nor are any items with these logos for sale to anyone other than parties authorized by the owners of such designs.

SAMPLES

We carry a large assortment of sample products, available by graphics and industry. Let us know your requirements and we will be happy to send them via ground shipping FREE of charge (in the 48 contiguous states). Additional charges apply for overnight or air shipments. NOTE: Not all combinations of options (stock color, foil color, ink color, emboss technique, coating finish, etc.) are available on every sample item.

SHIPPING

Freight F.O.B. factory in Michigan.

We normally ship U.P.S. ground delivery inside the contiguous U.S.A. For larger shipments, we use more economical motor freight. If you desire air shipment, please advise us and specify your carrier. If none is specified, we'll choose an efficient carrier. **Inside deliveries must be indicated on order. We cannot be held responsible for arrival date of shipment.**

SPLIT SHIPPING

We will split shipment to two destinations FREE of charge. There is a \$25.00 (R) charge for each additional destination.

STOCKS

Custom stocks are available upon request. Stock selection, manufacturers or availability may change without notice. All stocks are subject to occasional mill variations in texture, weight or color. **Not all stocks can be printed on (ColorCoats, MarbleCoats, etc.) or manufactured on all products.**

UNION LABEL

Our union label can be added to any imprint upon request for no additional charge. Products are manufactured in the U.S.A.



COLOR CHART

Letter codes represent price groups. All stocks are cover weight unless indicated.

Base Stocks

Semi-Gloss 12 PT C1S	Semi-Gloss 14 PT C1S	Smooth White 80 lb. C	Marble Crush White 12 PT C1S

Inserts / Brochures

Gloss Text 80 lb. C2S 10% 4C	Matte Text 80 lb. C2S 10% 4C	Gloss Text 100 lb. C2S 10% 4C	Matte Text 100 lb. C2S 10% 4C

Contains 10-100% post-consumer recycled fiber

FSC® mill certified paper from responsibly managed forests

Semi-Gloss

A 12 PT C2S	B 14 PT C2S	B 16 PT C1S	C 16 PT C2S	C 18 PT C1S

Gloss

B 120 lb. C2S 10% 4C

Dull

B 130 lb. C2S C

Cast Coated

C 12 PT C1S C

Eco Kraft

	<ul style="list-style-type: none"> • Sheets can vary in color. • Not available on all items.
A 18 PT 100% 4	

80 lb. Fiber

B White 30% 4C	B Natural 30% 4C	B Cream 30% 4C	B Gray 30% 4C	B Rose 30% 4C	B Ice Blue 30% 4C	B Thyme 30% 4C	B Periwinkle 30% 4C

80 lb. Felt

A Bright White 30% 4C	B Warm White 30% 4C	C Sandstone 50% 4C	C Pumice 50% 4C	C Forest Green 30% 4C	C New Black 30% 4C	D Granite 50% 4C

120 lb. Duplex Linen

	• Not available on all items.
G Blue / White C	

100 lb. Linen

B White 30% 4C	B Natural 30% 4C	C Sterling Gray 30% 4C	D Burgundy 30% 4C	D Merlot 30% 4C	D Dark Blue 30% 4C	D Deep Black 30% 4C	D Deep Pine 30% 4C	E Mahogany C	F Eggplant 30% 4C

100 lb. Smooth

A White C

80 lb. Smooth

C Eco White 100% 4C	C Eco Ivory 100% 4C

80 lb. Vellum

A Vanilla C	C Yellow 30% 4C	C Jute 50% 4C	D Leaf Green 30% 4C

100 lb. Vellum

D Aquamarine 30% 4

111 lb. Vellum

E Coral 30% 4C

90 lb. Hopsack

B White 30% 4C	D Forest Green 30% 4C	D Red C	D Deep Blue 30% 4C

80 lb. Grandee

D Smoke Gray C	E Charcoal C	E Blazer Blue C

90 lb. Cordwain

B White 30% 4C	D Deep Blue 30% 4C

14 PT C1S MarbleCoat

C Ash	C Burgundy	C Black	C Blue

14 PT C1S ColorCoat

C Navy	C Black

80 lb. Tweed

D Royal Blue 30% 4C

All colors shown are printed process representations. Consult a PMS book or actual stock swatches for color accuracy.

DIGITAL FOLDER COLOR CHART

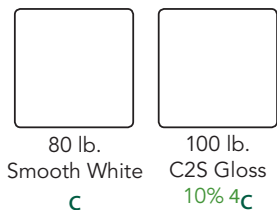

80 lb.
Smooth White
C

100 lb.
C2S Gloss
10% 4C



DOCUMENT FOLDER COLOR CHART

Standard Stock Selections for PMS Document Folders.

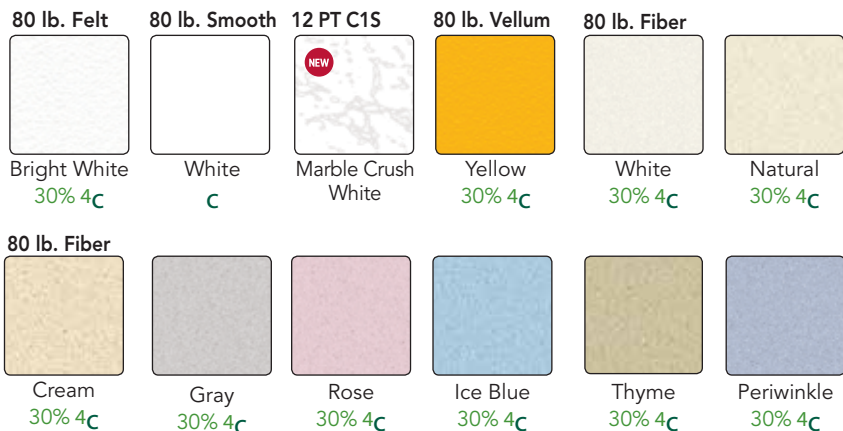

80 lb. Felt

Bright White
30% 4C

80 lb. Smooth

White
C

12 PT C15

NEW
Marble Crush
White

80 lb. Vellum

Yellow
30% 4C

80 lb. Fiber

White
30% 4C

Natural
30% 4C

80 lb. Fiber

Cream
30% 4C

Gray
30% 4C

Rose
30% 4C

Ice Blue
30% 4C

Thyme
30% 4C

Periwinkle
30% 4C

Standard Ink Colors for PMS Document Folders.

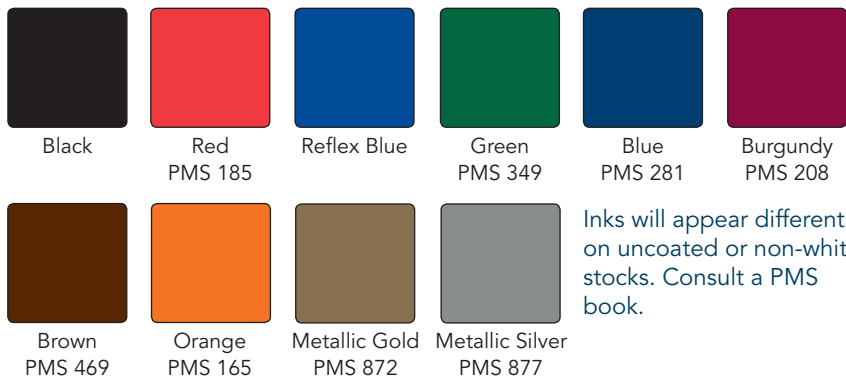

Black

Red
PMS 185

Reflex Blue

Green
PMS 349

Blue
PMS 281

Burgundy
PMS 208

Brown
PMS 469

Orange
PMS 165

Metallic Gold
PMS 872

Metallic Silver
PMS 877

Inks will appear different on uncoated or non-white stocks. Consult a PMS book.



POLARIS | SUZUKI | SKI-DOO | RONNIE'S CYCLE

OPEN 7 DAYS A WEEK
2012 W/2
Beverlyton, VT
Tel: (802) 44-XXXX
www.ronniecycle.com

SUZUKI | SUZUKI | SUZUKI | SUZUKI | SUZUKI

QUALITY DELIVERY CHECKLIST

Dorian Ford Phone: 866-792-4100
Toll Free: 888-856-1308
A Dealer you can recommend! Fax: 566-791-2180
Email: sales@dorianford.com

Visit Us @ www.dorianford.com
SALES DEPARTMENT OPEN
Mon., Thurs. 9:30am - 5:00pm • Tues., Wed., Fri. 9:30am - 6:00pm • Saturday 9:00am - 4:00pm

METALLIC FOILS

Clear and special effect foils are available – just ask.



Silver



Platinum



Pewter



Gold



Brass



Treasure



Copper

NEW



Gun Metal



Apple



Cranberry



Blue



Sapphire



Teal



Green



Lime

NON-METALLIC FOILS

Colors will look different when used on dark stocks.



White



Black



Blue



Pine



Red



Burgundy

EMBOSSING

Standard emboss is raised, one level ABOVE the surface of the paper. Emboss can be used in combination with foil stamping or printing for added impact. Best results are achieved with strong images, thick lines and bold type. See **Important Information** for recommended minimums.

**WE LOVE
FOLDERS**

Foil Plus One-Level Emboss
Font shown is Baskerville Bold
in 36 PT and 24 PT



Ink Plus
One-Level Emboss



One-Level
Blind Emboss



Expect MORE. Get MORE.